

VILLAGE OF HARRISON HOT SPRINGS NOTICE OF MEETING AND AGENDA



COMMITTEE OF THE WHOLE

Date: Tuesday, July 19, 2022 at 9:00 a.m.
Location: Council Chambers, Village Office, 495 Hot Springs Road,
 Harrison Hot Springs, British Columbia

THE MEETING WILL BE CONDUCTED IN PERSON

1. CALL TO ORDER	
Meeting called to order by Mayor Facio Acknowledgement of Sts'ailes Traditional Territory	
2. INTRODUCTION OF LATE ITEMS	
3. APPROVAL OF AGENDA	
4. ITEMS FOR DISCUSSION	
(a) Report of Operations Manager – July 11, 2022 Re: Subdivision Servicing and Development Bylaw – Bylaw 1179	Item 4(a) Page 1
(b) Report of Deputy Chief Administrative Officer/Corporate Officer – July 7, 2022 Re: Consideration of Home Occupation amendments under Business Licence and Regulation and Zoning Bylaws Recommendation: THAT the staff prepare draft amendments to Business Licence and Regulation Bylaw No, 1128, 2018 and Zoning Bylaw No. 1115, 2017 to allow “Home Occupation” business activities in all residential zones for those businesses who do not receive customers at their place of business.	Item 4(b) Page 151
(c) Report of Chief Administrative Officer – July 6, 2022 Re: Council Legacy Gift of Horseshoe Pits in Spring Park	Item 4(c) Page 153
(d) Report of Chief Administrative Officer – July 13, 2022 Re: Proposed Pesticide Ban Recommendation: THAT a bylaw be adopted that bans the use of non-essential pesticides within the Village of Harrison Hot Springs	Item 4(d) Page 155

<p>(e) Report of Community Services Manager – July 11, 2022 Re: Volunteer Recognition</p> <p>Recommendation:</p> <p>THAT Volunteer Recognition Policy 1.xx be adopted.</p>	<p>Item 4(e) Page 157</p>
<p>(f) Report of Community Services Manager – July 13, 2022 Re: Active Transportation Improvements</p> <p>Recommendation:</p> <p>THAT the Report regarding Active Transportation Improvements dated July 13,2022 be received for information.</p>	<p>Item 4(f) Page 159</p>
<p>5. ADJOURNMENT</p>	



**VILLAGE OF HARRISON HOT SPRINGS
BYLAW NO. 1179**

**A bylaw to regulate and to set standards for works and services in connection
with the subdivision servicing and development of land**

WHEREAS the Village of Harrison Hot Springs has deemed it advisable to establish a bylaw to regulate and to set standards for Works and Services in connection with the subdivision and development of land;

NOW THEREFORE in open meeting assembled, the Mayor and Council of the Village of Harrison Hot Springs enacts as follows:

CITATION

1. This Bylaw may be cited for all purposes as the Village of Harrison Hot Springs "Subdivision and Development Servicing Bylaw No. 1179, 2022".

BYLAW SECTIONS

2. This bylaw is divided into the following sections:
 1. Citation
 2. Bylaw Sections
 3. Bylaw Schedules
 4. Definitions
 5. Severability
 6. Authorization of Entry
 7. Compliance with Bylaw
 8. Subdivision and Development
 9. Application
 10. Security and Maintenance Security
 11. Design Requirements
 12. Construction Requirements
 13. Maintenance Period and Acceptance
 14. General
 15. Enforcement and Penalty
 16. Repeal

BYLAW SCHEDULES

3. The following Schedules form part of the requirements of this Bylaw and are attached hereto forming part of this bylaw:
 - Schedule "A" - Confirmation of Commitment
 - Schedule "B" - Design Standards
 - Schedule "C" - Construction Standards (Supplemental Standards to MMCD)

DEFINITIONS

4. The following definitions apply to this Bylaw;

"APPLICANT" means the Owner of a Parcel of land or an agent authorized in writing to make the application on behalf of the owner;

"APPROVAL" means written approval of a subdivision by the Approving Officer or issuance of a building permit by the Building Inspector;

"APPROVING OFFICER" means a person appointed pursuant to the *Land Title Act*, as amended from time to time, as an Approving Officer for the Village of Harrison Hot Springs;

"AWWA" means American Water Works Association;

"BUILDING OFFICIAL" means a person serving as Building Inspector for the Village of Harrison Hot Springs;

"BYLAW" means the "Subdivision Servicing and Development Bylaw No. 1138", as amended from time to time;

"COMMUNITY DRAINAGE SYSTEM" means a system of works owned, operated and maintained by the Village, designed and constructed to control the collection, conveyance and disposal of surface and other waters;

"COMMUNITY SANITARY SEWAGE SYSTEM" means a system owned, operated and maintained by the Village for the collection, treatment and disposal of sanitary sewage;

"COMMUNITY WATER SYSTEM" means a system of waterworks, within the meaning of the *Drinking Water Protection Act*, which is owned, operated and maintained by the Municipality;

"CONSULTING ENGINEER" means a professional engineer who is registered or duly licensed as such under the provisions of the *Engineers and Geoscientists Act* of the Province of British Columbia;

"CONTRACTOR" means the person or persons or the company undertaking the construction of works in a Subdivision Development, land development and/or on municipal property, or their employees, subcontractors or their duly authorized representative;

"CONSTRUCT" or "CONSTRUCTION" includes build, erect, install, repair, alter, add, enlarge, move, locate, re-locate, re-construct, upgrade, demolish, remove, excavate, or shore;

"COUNCIL" means the Municipal Council of the Village of Harrison Hot Springs;

"CUL-DE-SAC" means a length of local street made for vehicular use, the end of which is permanently closed either by subdivision design or by a natural feature such as inaccessible terrain;

"DEVELOPMENT" means any of the following:

- physically altering the landscape in any number of ways,
- changing the landform, from a natural state to a semi natural state,
- subdividing the Land,
- applying for a Land use change,
- a change in the use of any Building or Structure, and
- the carrying out of any, building, engineering or the construction, addition or Alteration of any Building or Structure;

"FEES" means those fees payable to the Village in connection with the Subdivision or Development of land, as prescribed the Miscellaneous Fees Bylaw as amended from time to time;

"FRONTAGE" means that length of a parcel boundary which immediately adjoins a highway (other than a lane or a walkway) or a waterbody (where access is via water). In the case of a parcel fronting on more than one highway, the narrower side of the parcel abutting a highway shall be its frontage;

"GENERAL CONDITIONS" means the following general conditions contained in Volume II of the Master Municipal Construction Document (MMCD) published by the Master Municipal Construction Documents Association as may be amended from time to time, and referred to in the Specifications and Standard Detail Drawings: GC 4.2 (Safety), GC 4.3 (Protection of Work, Property and Public), GC 4.4 (Temporary Structure and Facilities), GC 4.12 (Inspections), and GC 20 (Laws, Notices, Permits and Fees);

"HIGHWAY" includes a street, road, lane, bridge, viaduct and any other way open to public use, but does not include a private right-of-way on private property;

"LANE" means a Highway abutting a Rear Lot Line and is used to provide a secondary access or egress point to the Lot;

"LOT AREA" means the total land area of a lot contained within all of the lot lines measured on a horizontal plane and expressed in units of square metres;

"LOT DEPTH" means the means the greatest distance between the Side Lot Lines, excluding the access strip of a Panhandle Lot;

"LOT EXTERIOR OR STREET SIDE LINE" means a Lot Line common to the Lot and abutting a Highway and excludes a Lane or sidewalk;

"LOT FRONT LINE" means the Lot Line common to the Lot and an abutting Highway, provided that in the case of a Lot having more than one Lot Line abutting a Highway, the shortest Lot Line abutting a Highway must be considered as the Front Lot;

"LOT INTERIOR SIDE LINE" means a side lot line that is not common to or abutting a Highway and excludes a Lane or sidewalk;

"LOT LINE" means a line that is used to mark the boundaries of a lot;

"LOT REAR LINE" means the Lot line opposite of or the furthest from the front lot line;

"LOT WIDTH" means the greatest distance between the Side Lot Lines, excluding the access strip of a Panhandle Lot;

"MMCD" means the latest edition of the Master Municipal Construction Documents;

"MUNICIPALITY" means the geographic area within the Village of Harrison Hot Springs' boundaries as the context requires;

"OWNER" means a person registered in the records as owner of land or of a charge on land, whether entitled to it in the person's own right or in the capacity of the owner's authorized representative;

"PARCEL/LOT" means an area of land in which real property is held and improved or subdivided and includes a strata lot created pursuant to the *Condominium Act* and the related Bare Land Strata Regulations, as amended from time to time;

"POTABLE WATER" means water which is approved for drinking purposes by the Medical Health Officer in accordance with the *Drinking Water Protection Act*;

"SCHEDULES" means the schedules attached to this bylaw form part of this bylaw;

"STORM WATER MANAGEMENT PLAN" means a plan indicating the means by which storm water will be managed within or through a Development;

"SUBDIVISION" means the division of Land or Lots into two (2) or more Lots of Land, whether by plan, apt descriptive words or otherwise and includes a plan consolidating two or more Lots or Lots of Land into the same or a lesser amount of Lots of Land;

"SURVEYOR" means a land Surveyor currently licensed and registered in the Province of British Columbia;

"VILLAGE" means the Village of Harrison Hot Springs and/or its duly authorized agents;

"WALKWAY" means a narrow highway for the predominant use of pedestrian traffic;

"WORKS AND SERVICES" means any public service, facility or utility which is required or regulated by this Bylaw and without restricting the generality of the foregoing includes: the supply and distribution of water; collection and disposal of

sanitary sewage and drainage water; street lighting; highways, access roadways, curbs, gutters, and sidewalks; and natural gas, power, telephone and cablevision services;

"ZONE" means a zone as provided for in the Village of Harrison Hot Springs Zoning Bylaw in effect at the date of an application for subdivision and/or building permit;

SEVERABILITY

5. The provisions of this Bylaw are severable. If any provision is for any reason held to be invalid by the decision of any court of competent jurisdiction, such decision shall not affect the validity of the remaining provisions of this Bylaw.

AUTHORIZATION OF ENTRY

6. The Approving Officer, Building Inspector, or other authorized agent as delegated by the Village, is authorized to enter at all reasonable times upon any property or premises to inspect the same in connection with their duties under this Bylaw and to ascertain whether the provisions of this Bylaw are being complied with. It shall be unlawful for any person to prevent or seek to prevent or obstruct any authorized agent from the carrying out their official duty under this Bylaw.

COMPLIANCE WITH BYLAW

7. No person shall work or authorize or allow site work to proceed, including road Construction of any nature, until an application for subdivision or building permit has been processed to the stage where Approval has been granted by the Village

SUBDIVISION AND DEVELOPMENT

8. The following shall be taken into consideration:

Applicable Standards

- 8.1. Works and Services shall be constructed or installed:
 - in accordance with the standards set out in this Bylaw, or
 - where this Bylaw does not set out an applicable standard, as per the standards generally set out in the Master Municipal Construction Documents (MMCD); or,
 - where this Bylaw or the MMCD does not set out an applicable standard or a change in the design is required for engineering reasons and such change has been approved in writing by the Village, as per standards generally accepted as good engineering practice.

Works and Services

- 8.2. Owners of property located in the Village are required, as a condition of subdivision plan approval or building permit issuance, to provide Works and Services in accordance with this Bylaw.
- 8.3. The determination of which Works and Services are required onsite and offsite, in the case of a Subdivision or Building Permit shall be made by the Approving Officer.

Cost of Services

- 8.4. Unless otherwise provided in this Bylaw, all Works and Services required in this Bylaw shall be Constructed at the expense of the registered Owner of the land being subdivided or developed.

Right-Of-Way Agreement

- 8.5. Where an Owner is required to grant a right-of-way to the Village, the Owner shall provide a statutory right of way plan and agreement in a form acceptable to the Village and shall bear all costs associated with the preparation and registration of the plan and agreement.

APPLICATION

9. If specified by the Village, the Application, including Revised Application, must include:
- 9.1. an application, in the form prescribed by the Village, duly executed by the Owner or their authorized agent;
- 9.2. payment of Fees payable to the Village in connection with the Subdivision or Development of land,
- 9.3. a layout for the Subdivision that conforms to the requirements of the Village as to the size, shape and orientation of the Parcels, lot size, depth and frontage, street name, the location of existing structures and such other matters as may be prescribed by the Village from time to time;
- 9.4. confirmation that each of the beneficiaries of an existing or proposed right-of-way over the land approves the form of the proposed right-of-way;
- 9.5. confirmation that the Owner will remove or re-locate non-conforming structures on the lands;
- 9.6. site grading plan, storm water management plan, erosion control plan;

- 9.1. topographic, geotechnical and/or hydrological information;
- 9.2. if Works and Services are required in connection with the Subdivision, the following is required:
- a) a Works and Services Agreement, duly executed by the Owner in a form prescribed by the Village;
 - b) if applicable, a Landscaping Agreement, duly executed by the Owner in a form prescribed by the Village, including any required security deposit(s);
 - c) engineered design drawings for the proposed Works and Services;
 - d) a Construction schedule for the Works and Services;
 - e) a Certificate of Substantial Performance, a Maintenance Bond, a Statutory Declaration and as-built drawings;
 - f) Works and Services Security Deposit and Maintenance Security Deposit;
 - g) a grant or charge over the land on which the Works and Services are (or are to be) located, in a form required by the Village, granted to the Village in priority to all liens, charges and encumbrances, and executed in registrable form by the person who owns the land on which the Works and Services are (or are to be) located. The grant or charge may include, a Highway dedication, Statutory Right-of-Way, Highway Reservation Agreement, easement, approval, permit or license, as required by the Village.
 - h) such information, documents, agreements, covenants and Fees as are required by the Village;

SECURITY DEPOSIT, MAINTENANCE SECURITY DEPOSIT AND INSURANCE

10. The Owner must provide the Village with the following:

Security Deposit for Performance

- 10.1. All Works and Services Constructed at the expense of the Owner of the land being subdivided or developed shall be Constructed in accordance with the provisions of this Bylaw before the Approving Officer approves the subdivision. The Works and Services Security must be in the amount of 125% of the cost as estimated in writing by the Owner's Engineer and verified by the Village for the works and services. The Village may release or draw upon the Security, in whole or in part, on or at any time prior to completion of the Works and Services, for works described in the Works and Services Agreement.

Maintenance Security Deposit

- 10.2. Upon completion of the Works and Services the Owner must provide the Village with a Maintenance Security Deposit equal to:
- 10% of the cost of the Works and Services; or
 - \$5,000.00, whichever is greater.

The Maintenance Security Deposit may be withheld by the Village from the balance of the Security Deposit otherwise payable to the Owner. The Owner is obliged to maintain Works and Services for a period of one year after satisfactory completion inspection by the Village. The Village may draw upon the Maintenance Security Deposit, in whole or in part, during the maintenance period and, in the event of a deficiency.

Insurance

- 10.3. The Owner must provide and maintain, at the Owner's expense, at all times until the Certificate of Acceptance is issued, Comprehensive General Liability Insurance coverage, covering premises and operations liability, contingency liability with respect to the operations of contractors and sub-contractors, completed operations liability, contractual liability and automobile liability for owned, non-owned and hired units. The limits of liability must be not less than \$5,000,000.00 for each occurrence for bodily injury, death and damage to property. The policy or policies must be with a company or companies, and on such terms, as are acceptable to the Village. Each policy must provide that it cannot be cancelled, lapsed, or materially altered without at least thirty (30) days' notice in writing to the Village by registered mail, must name the Village and its officials and employees as an additional insured, and must contain a cross-liability clause. The Owner must deliver a copy of each insurance policy to the Village prior to the commencement of Construction of the Works and Services. If the Owner fails to obtain and maintain the said insurance or deliver the said policy or policies to the Village, the Village may but will not be obliged to obtain and maintain such insurance at the expense of the Owner.

DESIGN REQUIREMENTS

11. The Owner must complete the following:

Consulting Engineer

- 11.1. The Owner, at its expense, shall retain a Consulting Engineering Firm to design, inspect, test and certify all Works and Services.

Drawing Approval

- 11.2. The Owner must not Construct Works and Services without obtaining the Village's prior approval of the Consulting Engineer's design drawings. The Owner shall submit design drawings to the Village in the form and number required by the Village for this purpose. If the Village rejects the drawings, the Owner will be provided with reasons for the rejection and advice as to the Village's requirements. The Owner may re-submit the design drawings for approval and the provisions of this bylaw will apply to the re-submittal.

CONSTRUCTION REQUIREMENTS

12. The Owner must always, until a Certificate of Acceptance is issued by the Village, observe and perform the following:

Underground Utilities

- 12.1. Before commencing Construction of Works and Services, the Owner must locate all underground utilities and structures that might be affected by the Construction of Works and Services and must consult with all public and private utilities to locate any underground utilities of which they have records. The Owner must also locate any other utilities or underground structures that are reasonably apparent from an inspection of the area in which the Works and Services are to be Constructed.

Survey Monuments

- 12.2. The Owner must ensure that the proposed Development of the lands and adjacent lands will be part of a coordinated survey area based on universal transverse Mercator coordinates, and the Owner accordingly must install all necessary geodetic control monuments in completing the Works and Services and any Development on the lands. The Owner must protect all survey monuments and markers, pins, and posts during the Construction of the Works and Services and must employ, at the Owner's expense, a British Columbia Land Surveyor in good standing to replace any such monuments and markers, pins, and posts which may be moved, damaged, or destroyed during such Construction.

Safety

- 12.3. The Owner must provide all necessary safety devices and supervision in relation to the Construction of the Works and Services to protect the public. The Owner is responsible to comply with all BC WorkSafe Occupational Health and Safety Regulations.

Essential Services

- 12.4. The Owner must provide and maintain the essential services of:
- actual and reasonable access to and from the lands secured to the satisfaction of the Village, suitable for use by fire and emergency vehicles and equipment at all times; and
 - a water supply system, complete with operational fire hydrants for fire protection to each Parcel within the lands.

Traffic

- 12.5. The Owner must provide traffic signs, markers, barricades, and flag persons as required under by federal, provincial or municipal legislation and regulations to ensure the safe flow of traffic through the Construction area with a minimum of

disruption and nuisance to the public and adjacent land owners. For any disruptions to traffic on a right of way including pedestrian sidewalks, bike lanes and pathways, traffic control plans(s) are required and must be submitted to the Village and approved by the Village in advance of and development related works.

Watercourses

- 12.6. Unless otherwise permitted by the Village, the Owner must use care to not disturb any of the natural watercourses in and around the lands and must incorporate such protection and conservation methods as required by Federal, Provincial or local government enactments.

Property Damage

- 12.7. The Owner must protect the Works and Services, underground utilities and structures and property owned by third parties (including municipal, provincial and federal property) from damage and make good any damage to such Works and Services, utilities and structures or third-party property arising in connection with the Works and Services.

Compliance with Laws

- 12.8. The Owner must comply with all enactments, laws, statutes, regulations, and orders of any authority having jurisdiction, including bylaws of the Village.

Licences and Permits

- 12.9. The Owner must comply with and obtain all federal, provincial, municipal, and environmental licences, permits, and approvals required under applicable enactments.

Materials and Workmanship

- 12.10. The Owner must provide materials and workmanship in Constructing the Works and Services that are not defective or faulty, materials provided must be new, and products that are not specified by this bylaw must be of a quality best suited to their purpose and use.

Encumbrance

- 12.11. The Owner must ensure that Works and Services are kept free and clear of any and all liens, charges or encumbrances.

Record Documents

- 12.12. As noted in the Schedule B – Design Standards, the Owner must provide the Village with detailed, reproducible as-built record drawings of the Works and Services,

sealed by the Consulting Engineer, and Village compatible digital files, as Constructed as of the date of Completion

- 12.13. As noted in the Schedule B – Design Standards and if requested, the Owner must provide the Village with a table of contributed assets at the time of substantial completion.

MAINTENANCE PERIOD AND ACCEPTANCE

13. After the date of the Certificate of Substantial Performance:

- 13.1. The Owner, at its expense, must promptly complete, modify or re-construct any incomplete, defective or deficient Works and Services that appeared on the date of the inspection by the Village of completed Works and Services. The Owner must thereafter schedule a field inspection with the Village. Upon verification by the Village that completion has been achieved, the Owner must provide the Village with:
- confirmation in writing from the Land Surveyor (B.C.L.S.) that all survey pins have been installed on the Parcel;
 - any revisions to the detailed, reproducible and sealed as-built drawings of the Works and Services in paper and digital form

Repair by Owner During Maintenance Period

- 13.2. The Owner must correct, repair or otherwise remedy any defects or deficiencies in the Works and Services that become apparent during a Maintenance Period within a period agreed to by the Village.

Acceptance by Village

- 13.3. Upon the expiration of all Maintenance Periods, and verification by the Village that all information, documents, agreements, covenants and Fees required from the Owner and Consulting Engineer, including as-built drawings, pursuant to this bylaw have been provided to the Village, the Village will:
- provide the Owner with a Certificate of Acceptance of all Works and Services; and
 - release to the Owner the balance of the Maintenance Security Deposit.

Routine Maintenance by Village

- 13.4. Subject to the fulfilment of the obligations of the Owner and its Consulting Engineer, the Village will be responsible, at its expense, for the ordinary and routine maintenance of the Works and Services; provided that if during a Maintenance Period the Works and Services cease to function for their intended purpose through no fault of the Village, the Village will not be responsible for such maintenance until the deficiencies are corrected and the Maintenance Security Deposit is restored in full.

GENERAL

14. The following shall be taken into consideration:

No Duty of Care

- 14.1. This bylaw does not create a duty of care on the Village, the Approving Officer, the Building Inspector, the Village, or employees or agents of the Village in respect of:
- the issuance of the Preliminary Layout Approval Letter;
 - the approval of an Application for Subdivision;
 - the issuance of a building permit in connection with an Application for Building Permit;
 - the review of a layout and Subdivision plans;
 - the review of Works and Services specification requirements, design and Construction drawings, and supporting documents;
 - the issuance of a Certificate of Acceptance;
 - inspections made by the Building Inspector, site visits made by the Approving Officer or Village, or failure to make such inspections or site visits;
 - the approval of any application for utility servicing;
 - the enforcement or failure to enforce the *Community Charter, Local Government Act, Land Title Act*, Building Bylaw, or the provisions of this bylaw.

The Owner will not be entitled to rely upon the results of any investigations, inspections, field visits or other due diligence conducted by the Village in connection with the Subdivision or Development of the lands.

No Cause of Action

14.2. Neither a failure to administer or enforce, nor incomplete or inadequate administration or enforcement of the *Community Charter, Local Government Act, Land Title Act*, Building Bylaw, or the provisions of this bylaw, nor any error, omission or other neglect in relation to any matter of this bylaw will give rise to a cause of action in favour of any person including the Owner.

14.3. No Warranty or Representation

- A review, or failure to review, by the Village of Works and Services specification requirements, design and Construction drawings, and supporting documents will not, in any way, constitute a representation, warranty or statement that the design of the Works and Services complies with the design standards as set out in Schedule B of this Bylaw, or that the Construction of the Works and Services complies with the construction standards as set out in Schedule C of this Bylaw, and no person, including the Owner, will rely on such review or failure to review as establishing compliance with this bylaw.
- A verification by the Village as to the completion of the Works and Services will not, in any way, constitute a representation, warranty or statement that the Construction of the Works and Services have reached Substantial Performance or Total Performance.
- The issuance by the Village of a Certificate of Acceptance will not, in any way, constitute a representation, warranty or statement that the Construction of the Works and Services have reached Total Performance.
- Site visits made by the Approving Officer, Village, or any other officer, employee or agent of the Village, or the failure to make such site visits, will not, in any way, constitute a representation, warranty or statement that the Works and Services have been designed and Constructed in accordance with this bylaw.

Owner's Responsibility for Works and Services

14.4. It will be the full responsibility of the Owner to design and Construct any Works and Services that are required hereunder to be designed and Constructed by the Owner, and to ensure that the Works and Services are inspected, tested and certified in accordance with this bylaw and other bylaws of the Village, and none of the issuances, approvals, reviews, verifications or inspections which are performed or failed to be performed by the Village, including the Approving Officer, Village or any other officer, employee or agent of the Village, will relieve the Owner from this responsibility. Without limiting the generality of the foregoing, neither the review and approval of the Village of the Owner's design drawings in connection with the Works and Services, the expiration of any or all Maintenance Periods, nor the issuance of a Certificate of Acceptance, will relieve the Owner, Consulting Engineer or Consulting Engineering Firm from any responsibility or liability for the faulty, defective or deficient design or Construction of the Works and Services, or for any breach of this bylaw or any agreement between the Village and the Owner in connection with this bylaw, whether such responsibility or liability arises before or

after the Village's approval of the Owner's design drawings or the Village's issuance of the Certificate of Acceptance.

Owner's Cost

14.5. Notwithstanding anything else contained herein, all documents, agreements, covenants and information required from the Owner in connection with the Subdivision or Development of the Owner's land, the registration of any documents requiring registration, and the performance of the Owner's obligations hereunder, must be provided at the sole cost and expense of the Owner.

ENFORCEMENT AND PENALTY

15. Except where the penalty is otherwise provided for in the *Community Charter*, or *Local Government Act*, every person who offends against any of the provisions of this Bylaw, or who suffers or permits any act or thing to be done in contravention or violation of the provisions of this Bylaw, or neglects to do or refrains from doing anything required to be done by this Bylaw, shall be deemed to have committed an offence under this Bylaw and shall be liable, to fines specified under the Bylaw Notice Enforcement Bylaw.

16. Each day that a violation is permitted to exist constitutes a separate offence.

REPEAL

17. "The Corporation of the Village of Harrison Hot Springs Bylaw No. 578, 1993 and amendments thereto are hereby repealed in their entirety.

READINGS AND ADOPTION

READ A FIRST TIME THIS DAY OF , 2022

READ A SECOND TIME THIS DAY OF , 2022

READ A THIRD TIME THIS DAY OF , 2022

ADOPTED THIS DAY OF , 2022

Mayor

Corporate Officer

CONFIRMATION OF COMMITMENT

DATE: _____

FILE NUMBER: _____

CIVIC ADDRESS:

To:

The Village of Harrison Hot Springs

Re: _____

Name of Project (Print)

Description of Project (Print)

The undersigned has been retained as a Coordinating Registered Professional to coordinate the design work and Village submissions of the Registered Professionals required for this project in order to ascertain that the design and construction of the project will substantially comply with the Village's Subdivision and Development Servicing Bylaw No. 1179, 2022.

The Owner and the Coordinating Registered Professional understand that where the Coordinating Registered Professional or a Registered Professional cease to be retained at any time during construction, the work on the above-mentioned project will cease until such time as a new Coordinating Registered Professional or Registered Professional, as the case may be, is retained in the profession/discipline relevant.

The undersigned Coordinating Registered Professional certifies that they are a Registered Professional and agrees to coordinate the design work and Village submissions of the Registered Professionals required for this project.

Coordinating Registered
Professional's Seal and Signature

Owner's Signature

Name (Print)

Name (Print)

Address (Print)

Address (Print)

1 INTRODUCTION

Schedule "B" Index

1	INTRODUCTION	1-1
2	WATER	2-1
3	SANITARY	3-1
4	DRAINAGE	4-1
5	ROADWAYS	5-1
6	LANDSCAPE AND IRRIGATION	6-1
7	ELECTRICAL	7-1

DRAFT

1 INTRODUCTION

This latest update of Schedule "B" is based on the Municipal Infrastructure Design Guidelines 2014 as prepared under the auspices of the Master Municipal Construction Document Association (MMCDA), which is an association of British Columbia Municipalities, Regional Districts, Contractors and Consultants. The purpose of the Design Standards is to provide a standardized set of guidelines to be utilized by consultants and Village staff involved with design and construction of municipal infrastructure. Users of this Schedule should note the following:

- All work is to meet MMCDA standards or better
- These Standards are considered a "living document" and will be updated on a regular basis to reflect evolving industry advancements, new materials, improved methods and best practices.
- The contents of this manual are intended to complement the following documents:
 - MMCD Specifications and Standard Detailed Drawings.
 - Supplementary Specifications and Supplementary Standard Detailed Drawings.
- Links to other documents have been provided to augment the material included in these Design Standards.

This manual is not intended to be a substitute for sound engineering knowledge and experience. It is the engineer's responsibility to exercise professional judgment on technical matters in the best interests of the owners and users of the infrastructure. Standards contained herein are provided to assist in making these judgments but should not be used as a substitute. Since the standards are general, they do not, and cannot, cover all particular cases.

DISCLAIMER:

This manual is not intended to be used as a basis for establishing civil liability.

1.1 General Design Considerations

1.1.1 Sustainability and Asset Management

Development of appropriate design guidelines for municipal infrastructure involves consideration of the principles of sustainability and asset management. These principles include the following:

- Improve and enhance quality of life
- Minimize negative impacts on health, safety and the environment
- Investigate the impacts of potential actions to manage and mitigate risk
- Consistently make informed long-term infrastructure decisions
- Minimize overall life cycle investment

Some of the above principles involve conflicting priorities, for example, undue concentration on financial economies may have adverse impacts on environmental protection and life cycle costs of infrastructure. A balanced approach to design of municipal infrastructure requires careful consideration of all of the above principles

1.1.2 Independent Utilities

Independent utilities are those not normally supplied by municipal or regional authorities and are not included in these guidelines. Independent utilities include:

- Electrical power
- Communications (telephone, data, fibre optics and cable)
- Gas

Design of municipal infrastructure must include consideration of the above utilities. Design of these utilities is normally carried out by the utility owner and coordinated for conflicts by the consulting engineer and reviewed by the Village.

In new urban developments, all wiring is generally to be underground. This excludes electrical transmission lines, which are normally located in separate rights-of-way.

1.1.3 Utility Rights-of-Way

Utility right-of-way locations should be selected to avoid environmentally sensitive areas, such as, watercourses, wetlands, wildlife migration corridors and forested areas.

Where the location of a municipal utility in a right-of-way is approved by the Village, the minimum desirable right-of-way widths are as follows:

Table 6-1 - Right-of-Way Widths

Service Type	Right-of-Way Width
Single service	Twice the depth from surface to the crown of the pipe plus trench width (4.5 m minimum width).
Two services within the same trench	Twice the depth from surface to the crown of the deeper pipe PLUS trench width (5.5 m minimum width).
Two or more services adjacent to one another but in separate trenches	Cumulative widths for single services (noted above) PLUS any difference to provide the required separation (6 m minimum width).

Table 1-1 Notes:

1. When the service is within a road allowance, and the distance from the property line to the centre of the service is less than one half of the width indicated above

for a single service, the difference should be provided as right-of-way on the adjacent property.

2. The rights-of-way noted are desirable but, in some cases, may not be practical and alternative combined right-of-way corridors may be required as approved by the Village.

In all cases, the width of rights-of-way should be sufficient to permit an open excavation with side slopes in accordance with the WorkSafeBC requirements for excavation and trenching safety, without impacting on or endangering adjacent structures.

Where required, sanitary trunk and interceptor sewers should have rights-of-way wide enough for future widening and/or twinning. The width of the right-of-way should be the required separation between pipe centrelines plus two (2) times the depth to the crown of the deeper sewer.

The design should provide cross sections indicating the minimum safe distances to adjacent building footings based on a safe angle of repose from the limits of the excavation.

Where a utility is located within a right-of-way, and valves, valve chambers, manholes, or other appurtenances which require maintenance are located within a right-of-way, maintenance road access from a public road must be provided. The maintenance access must be sufficiently wide and structurally adequate to support the maintenance vehicles for which the access is intended.

1.1.4 Utility Separation and Alignment

Requirements for separation of sanitary sewer, storm sewers and water mains are as follows:

- The following minimum (pipe wall to pipe wall) should be maintained between a water main and either a sanitary sewer or a storm sewer, unless otherwise indicated by the Fraser Valley Health Authority:
 - 3.0 m horizontally
 - 0.5 m vertically above or below water pipe and in separate trench if 3.0 m horizontal separation is not possible
- Minimum separation of storm sewer from sanitary sewer is 1.5 m horizontally
- Service connections, if approved, should be located adjacent to sanitary service connection at property line and shall be as shown on the standard drawings
- See standard drawings for typical location of utilities within road right-of-way

In situations where the minimum separations cannot be attained, protection of the watermain may be considered subject to the acceptance of such proposals by the Fraser Valley Health Authority and the Village.

The designer shall obtain Fraser Valley Health approval for all watermain designs prior to commencement of construction.

1.1.5 Sewers in Common Trench

In special circumstances when typical separation cannot be reasonably achieved, storm and sanitary sewers may be installed in a common trench provided that the design has taken into account:

- Interference with service connections
- Stability of the benched portion of the trench
- Conflict with manholes and appurtenances

The vertical clearance between pipes shall be minimum 1.0 m invert-to-invert. The horizontal clearance between sewer pipes should be not less than 1.0 m. Separation between manholes should be not less than 0.3 m.

1.1.6 Seismic and Geohazard Design Standards

Underground utilities are at risk of damage caused by seismic events, soil liquefaction and landslides. The most significant seismically-triggered geo-hazard that underground utilities are exposed to is horizontal ground displacement from landslides and soil liquefaction induced lateral ground displacement. Seismic design standards must be considered with a potential for landslide or soil liquefaction. This becomes even more critical when considering a shared fire flow and potable water distribution system, which, during a severe seismic event, is required to remain functional if it is to be relied upon to provide fire suppression throughout the community.

The design shall consider the stability of the soils present, as well as establishing the site's susceptibility to lateral ground displacement during seismic activity.

Underground utilities along with seismically resistant pipe connections, shall be individually assessed by civil, geotechnical and structural engineers using the latest edition of BC Building Code and Application of the Seismic Guidelines for Government to meet post-disaster requirements and other specialty seismic standards applicable to buried and above ground structures.

1.1.7 Referenced Standards

All referenced standards contained within (i.e. AWWA, BC Building Code, Water Supply for Public Fire Protection, etc.) are to be the most recent version unless specifically noted otherwise.

1.1.8 Record Documents

Record drawings are to be prepared and submitted to the Village. Record drawings shall include relevant construction and design information. Notes shall be modified to reflect actual construction. Any existing infrastructure that has been abandoned in place must remain on the drawing and be labeled accordingly. Any infrastructure removed during construction must be deleted from the record drawings.

AutoCAD data shall be forwarded to the Village in a format requested by the Village. The AutoCAD data submission must be same file that was used to generate the hard copy.

Failure to comply will result in work being returned to the Owner for correction at the Owner's expense.

Service connection cards, Service disconnect cards and hydrant data sheets in the format requested by the Village are to be forwarded to the Village at the time of submission of the record drawings. The service records shall clearly detail the location of all services. If connections are skewed to the property line, the connection shall be located at the main by showing the distances from property lines as well as located at the property line. The hydrant data sheets must be supplied for each hydrant and include fire flow data.

The following procedures shall be followed in the submission of Record drawings for Village acceptance:

- Record documents and service information must be submitted prior to scheduling a substantial completion inspection.
- Sealed record drawings. One marked-up set of the record prints may be returned to the Owner for revisions.
- Drawings must be signed and sealed by the design engineer, a qualified professional engineer in good standing registered in British Columbia. The drawings must contain either no disclaimer or the following statement:

"I hereby give assurance that the new works shown on this drawing were inspected during construction and substantially reflect the installed works in all material aspect"

- Record drawings shall include the following drawings:
 - All drawings contained in the issued for construction set.
 - Design drawings not requiring "Record" but shall be included as paper prints for Village records are:
 - Storm Water Management Plan.
 - Erosion and Sediment Control Plan.
 - Road cross sections.
- A table of contributed assets is to be prepared and submitted to the Village. The table of contributed assets must identify:
 - All the assets being contributed to the Village
 - Quantity of each asset contributed, and
 - The installed cost of each contributed asset
- If applicable, Operation and Maintenance Manuals are to be prepared and submitted to the Village. Operation and Maintenance Manuals are to be prepared and submitted for pump stations, lift stations, reservoirs, valves, air valves and appurtenances as described below:
 - Supply two (2) paper copies and one (1) electronic copy of operating and maintenance manuals prior to substantial completion.
 - Bind contents in a three-ring, hard covered, plastic jacketed binder with the name of the facility to be embossed onto binder cover and spine. Each

section shall be separated from the preceding section with a plasticized cardboard divider with a tab denoting contents of the section.

- Contents to include:
 - Title sheet labelled "Operation and Maintenance Instructions", and containing project name and date
 - List of contents
 - Reviewed shop drawings of all equipment
 - Equipment list showing all model and serial numbers
 - All equipment manufacturers manuals
 - Record drawings of all mechanical, electrical, control and alarm installations
 - Full description of system operations including: design points, designed pump and system curves, ultimate capacity, area served and any relevant design criteria relevant to the operation of the system
 - Full description of entire mechanical, electrical and alarm system operation
 - Names, addresses and telephone numbers of all major sub-contractors and suppliers
- Commissioning report showing pressures, flows, current drawings for all possible operating conditions

1.1.9 Interpretation

If there is any inconsistency or conflict between the provisions of these Design Standards and the Standard Drawings the Design Standards shall govern.

2 WATER

CONTENTS

2	WATER	2-1
2.1	General	2-2
2.2	Metering	2-2
2.3	Alignments and Corridors	2-3
2.4	Per Capita Demand	2-3
2.4.1	Residential	2-3
2.4.2	Non-Residential Demand	2-3
2.5	Fire Flows	2-4
2.6	Design Flows	2-4
2.7	Water Pressure	2-5
2.8	Hydraulic Design	2-5
2.9	Minimum Pipe Diameter	2-6
2.10	Dead Ends	2-7
2.11	Minimum Depth of Cover	2-7
2.12	Grade	2-7
2.13	Corrosion Protection	2-7
2.14	Valves	2-8
2.15	Hydrants	2-8
2.16	Blow Offs	2-9
2.17	Test Points	2-10
2.18	Air Valves	2-10
2.19	Thrust Restraint	2-10
2.20	Chambers	2-11
2.21	Service Connections	2-11

2.1 General

These guidelines are not intended to be a substitute for sound engineering practices. Water distribution system designs should be prepared under the direction of a design professional who has the appropriate experience and is registered with Engineers and Geoscientists British Columbia.

Consulting Engineers retained by the Owner to design the works and services must consult with the Village to determine what existing information may be of assistance to them.

2.2 Metering

Water meters tend to reduce per capita water demand and are required to be installed meeting the BC Building Code requirements. See the standard drawings for details.

The water meter box or chamber and water meter setter models determined by size in the table below, or a Village approved equivalent, are required for all new preservice water connections. All meter chambers for 100 mm, 150 mm, 200 mm and 250 mm meter sizes shall be installed with a lid complete with galvanized steel hatch.

Size	Meter Box/Chamber Model	Meter Setter Model
19 mm (3/4")	B-937	Ford VBHH92-15W-44-33A-Q
25 mm (1")	T266	Ford VBHH92-15W-44-44A-Q
38 mm (1.5")	T266	Ford VBHH76-86-12BHC-1166 c/w #6 idler and 2 Ford model C87-66 pack joint couplers
50 mm (2")	5686	Ford VBHH77-87-12BHC-177 c/w #7 idler and 2 Ford model C87-77 pack joint couplers
100 mm (4")	2121	-
150 mm (6")	2121	-
200mm (8")	2121	-
250 mm (10")	3151	-

2.3 Alignments and Corridors

On straight roads, watermains should have straight alignments with uniform offsets between intersections.

For curved roads and alignments, where approved by the Village or their Consultant Engineer, design joint deflections shall be limited to half the maximum deflection specified by the pipe manufacturer or through the use of 5-degree bends. Pipe alignment to be at a parallel offset with an established road right-of-way or property line.

Where a water main crosses private land, a right-of-way in favour the Village will be required as indicated in Section 1.1.3.

Watermain clearance from sanitary sewer and storm sewer is as indicated in Section 1.1.4.

2.4 Per Capita Demand

2.4.1 Residential

Use the following per capita demands for future residential requirements:

- Average annual daily demand (ADD): 576 litres per capita per day (L/c/d)
- Maximum day demand (MDD): 1152 litres per capita per day
- Peak hour demand (PHD): 1728 litres per capita per day

Design population density:

- Single Family: 3.0 people/dwelling
- Multi-Family: 2.0 people/dwelling

2.4.2 Non-Residential Demand

Commercial, industrial and institutional demands should be determined using specific data related to the development or zoning. In the absence of such data, or municipal regulations, use the following for maximum day demands (MDD):

- Commercial (C-4) per m² 1.20 L/day
- Commercial (C-5) per m² 1.33 L/day
- Commercial (Other) per m² 1.66 L/day

Note that the above rates do not include outdoor irrigation and assume that all connections are metered.

- $ADD = MDD \times 0.5$
- $PHD = MDD \times 1.5$

2.5 Fire Flows

Fire flows shall be determined in accordance with the requirements of the current edition of "Water Supply for Public Fire Protection - A Guide to Recommended Practice", published by Fire Underwriters Survey.

The minimum fire flows indicated in Table 2-1 must be met for the noted zones under peak daily flow conditions:

Table 2-1 Minimum Fire Flow Requirements

Developments	Minimum Fire Flow
Single Family & Two Dwelling Residential	60 L/s
Modular/Mobile Home	60 L/s
Three & Four Plex Housing	150 L/s
Apartments, Townhouses	150 L/s
Commercial	150 L/s
Institutional	150 L/s
Industrial	225 L/s

Table 2-1 Notes:

1. The designer shall not use a fire flow greater than those listed in Table 2-1 to design their onsite fire protection systems.
2. Subdivisions and main extensions may utilize hydraulic information from water model as provided by the Village.
3. Actual required fire flows shall be determined for all new developments.

2.6 Design Flows

Unless otherwise indicated by the Village or their Engineer, system design flows should be based on the ultimate population and fully developed non-residential land as anticipated in the Official Community Plan.

Total design flows (Q design) are to be the greater of the following:

- Q design = MDD+FF Maximum Day Demand plus the Fire Flow, or
- Q design = PHD Peak Hour Demand

2.7 Water Pressure

The water system must be designed to provide domestic water at the building main floor elevation on each Parcel as follows:

- Maximum allowable static pressure 830 kPa (120 psi)
- Minimum static pressure 275 kPa (40 psi)
- Minimum system pressure at Peak Hour Demand (PHD) 275 kPa (40 psi)
- Minimum pressure in system during emergency of
Maximum Day Demand plus Fire Flow (MDD+FF) 140 kPa (20 psi)

For large lot and hill side development the designer shall be responsible to identify suitable building elevations for all buildings based on available hydraulic pressure. Determination of pressure limits should include consideration of property elevations relative to street level. Designer to note properties on service cards and record drawings where pressure at service connection exceeds 75 psi. Where the maximum pressure exceeds 515 kPa (75 psi), the design must identify service connections that must be individually protected by pressure reducing valves located in the buildings being served.

2.8 Hydraulic Design

Where there is an existing hydraulic network in place, the Village will provide any available information for assistance in designing changes to the network. Depending on the complexity and extent of the proposed distribution system, the Village may require a hydraulic analysis design showing flows and pressures.

Use a proven network analysis computer model based on the Hazen-Williams formula:

$$Q = \frac{C D^{2.63} S^{0.54}}{278,780}$$

Where:

Q = Rate of flow in L/s

D = Internal pipe diameter in mm

S = Slope of hydraulic grade line in m/m

C = Roughness coefficient as per Table 2-2

Table 2-2 Roughness Coefficients for Various Pipe Materials

Pipe Material	Roughness Coefficient - C
PVC, HDPE	130
Cement Lined Ductile Iron, Cement Lined Steel, Asbestos Cement	120
Cast Iron	100

It should be noted that the values listed in the above table are for pipe losses only and do not include losses associated with fittings, tees and valves which also require design consideration.

The maximum allowable design velocity shall not exceed the following:

- Pump Supply, Reservoirs and Trunk Mains 2.0 m/s
- Distribution Lines
 - At Peak Hour Demand (PHD) 2.0 m/s
 - At Maximum Day Demand (MDD) plus Fire Flow (FF) 4.0 m/s

Designers are responsible for assuring that surge and transients pressures are accounted for in their design.

When water mains crossing major regional roads including Provincial highways, or watercourses, a casing pipe must be provided and must be designed to all applicable static, dynamic and seismic loadings and all other requirements of the authority having jurisdiction. The water main must be constructed with the appropriate spacers to support the pipe and prevent sagging or uplift (floating) inside the casing pipe. The water main inside the casing must be joint restrained. Service connections crossing highways and railroads are not recommended and require approval from the Village.

2.9 Minimum Pipe Diameter

- Distribution mains: 200 mm
- Fire hydrant connections: 150 mm
- Service connections: 19 mm HDPE Series 160
CTS

Service diameter for buildings with sprinklers to be determined on a case-by-case basis based on fire flow demand.

For looped distribution mains in residential subdivisions, the diameter can be reduced to 150 mm, providing that fire flow and all other hydraulic requirements can be met.

Subject to approval of the Village or their Consultant Engineer, distribution main minimum diameter in residential areas may be reduced to 100 mm provided that the main terminates in a short residential cul-de-sac, has a length less than 50 m, serves no fire hydrants or fire sprinkler systems and where no further extension is planned.

For commercial/industrial/institutional areas, the minimum allowable water main size shall be 200 mm diameter.

2.10 Dead Ends

Water mains must be looped wherever possible. Where dead ends are unavoidable, and approved by the Village, blow-offs shall be provided (see Section 16.0 for sizing). The maximum length of any permanent non-interconnected water main is 200 m. All mains exceeding 200 m in length, unless it is a temporary situation, must be looped. Where the water system network is deficient, installation of additional water main capacity may be required and may necessitate the provision of rights-of-way in favour of the Village.

2.11 Minimum Depth of Cover

The cover over any water main must not be less than 1.0 m from pipe crown to surface. U-bends should be used to avoid conflict and maintain minimum depth of cover. Rigid insulation may be used to provide protection to the water main from freezing for short sections of water main (<6 m) with approval from the Village, as per manufacturer's recommended guidelines or Utility line insulation (ex. DOW Tech Solutions 602.0 Styrofoam Brand Highload Insulation for Buried Utility lines).

2.12 Grade

Water mains must be designed with a rising grade wherever possible, to minimize high points in the main. Grades should be straight lines between defined deflection points. Elevations should be recorded on record drawings.

The minimum grade of water mains shall be 0.1%. Grading should be designed to minimize the number of high points and maintain continuous grade.

When the slope exceeds 10%, provide anchorage, joint restraints, trench dams and trench drainage as per standard MMCD drawing G8. Provide geotechnical engineering report where appropriate that assesses slope stability.

2.13 Corrosion Protection

Where there is a potential for encountering corrosive soils, a geotechnical corrosion analysis on the alignment of any proposed metallic water main or metallic appurtenances shall be conducted to determine the corrosiveness of the native soils and the suitability of metallic pipe and appropriate corrosion protection measures. As per MMCD Specification Section 26 42 13, Cathodic Protection.

Regardless of soil condition, all metallic pipe and fittings, shall be field coated with a petrolatum tape and wax or approved alternative. The fitting surfaces and coating

application shall be as recommended by the manufacturer and/or to the ANSI AWWA C217 -Petrolatum Tape/Wax specifications.

Petrolatum tape and paste shall be used to wrap all nuts and bolts on buried metallic fittings and joint restraint fasteners.

2.14 Valves

In general, valves should be located as follows:

- In intersections, either in a cluster at the pipe intersection or at projected property lines to avoid conflicts with curbs and sidewalks:
 - 4 valves at "X" intersection
 - 3 valves at "T" intersection or, as directed by the Village, in order to allow for the isolation of specific sections of the main, minimize service disruption and/or facilitate network operation and maintenance
- Not more than 200 m apart (except on trunk mains greater than 300 mm diameter, where spacing can be increased upon approval of the Village)
- In locations and at a frequency so that not more than two hydrants are out of service when a section of the main is turned off. An isolation valve is required for each hydrant, typically flanged to the hydrant tee
- Not more than 20 service connections isolated

In order to permit the use of pigging cleaning methods the valve sizing and type selection should be as follows:

- The valves shall be the same diameter as the water main
- All valves shall be gate valves. Butterfly valves with appropriate chamber sized for maintenance and replacement may be used in special circumstances for water mains greater than 400 mm with approval from the Village

2.15 Hydrants

In general, fire hydrants should be located at street intersections and as follows:

- Not more than 150 m apart in single family residential areas measured along road centre line
- Not more than 90 m apart in higher density residential, commercial, industrial and institutional areas
- Hydrant locations as per BC Building Code for all buildings
- In accordance with "Water Supply for Public Fire Protection - A Guide to Recommended Practice" (latest edition), published by Fire Underwriters Survey
- 1.5 m back from curb or 0.5 m back of sidewalk to centre line of hydrant
- Centre of any hose outlet shall not be less than 575 mm above final grade

- The hydrant barrel flange is to be a minimum of 100 mm and a maximum of 150 mm above the finished grade adjacent to the hydrant location
- Minimum 1.0 m clear of any other utility above grade structure in all directions
- Minimum 3.0 m clear in direct line with hose connections
- At property lines in mid-block locations
- SRW required where open cut excavation to base of hydrant assembly extends into private property
- Bollards or concrete barriers for hydrant protection may be required at the Village's discretion

Hydrants shall not be located on sidewalks. Where this is not possible and with approval from the Village, a minimum distance of 1.5 m must be maintained between the front of the pumper port and the back of curb, in accordance with the Transportation Association of Canada Manual for Canadian Roads.

On arterial highways with, or designated to be constructed with, a raised median, fire hydrants shall be installed on both sides of the highway with each side treated exclusively for spacing requirements.

All public and private hydrants are to be painted with self-priming urethane enamel as follows:

Public:

- Body – Red
- Top – Red
- Pumper Port Cap – White
- Hose Port Caps (2) – White

Private:

- Body – Yellow
- Top – Mid-Green
- Pumper Port Cap – Black
- Hose Port Caps (2) – Mid-Green

2.16 Blow Offs

Blow-offs shall be provided at low points, as required by the Village or their Consultant Engineer, and the terminal ends of all water mains whether permanent or temporary. Blow-offs shall be installed within the boulevard, behind the curb or sidewalk, wherever possible. Blow-off as per MMCD drawing W8 and sizes as follows:

- 50 mm dia. for 100 mm dia. water mains
- 100 mm dia. for 150 mm dia. and larger water mains

2.20 Chambers

Chambers or manholes should allow adequate room for maintenance, including headroom and side room. These structures are to be located in the boulevard areas wherever possible. Chamber access openings must allow for ease of entrance by using a light lockable H20 loading hinged door where there is any possibility of vehicles crossing it. These structures must be suitable for removing valves and equipment and permitting inspection cameras and pigging equipment. A ladder shall also be installed in each chamber.

The chamber is to be provided with a drain to a storm sewer or ditch, complete with backflow prevention, to prevent flooding of the chamber. Rock pits may be considered subject to suitable soil and groundwater conditions and subject to approval by the Village. A pumping system may be required for drainage.

Adequate venting should be provided. The Village may require provision of forced ventilation, lighting, heating and dehumidification. Access and ventilation details must comply with WorkSafe BC requirements.

Insulation to prevent freezing should be provided where necessary.

2.21 Service Connections

Service connection size should be calculated on the basis of the designated land use including sprinkler systems and/or on-site hydrants, where applicable. The minimum size is outlined in 2.9 - Minimum Pipe Diameter.

All service connections to be made with service saddles at water main. Multiple corporation stops must have a minimum spacing of 1.0 m. The curb stop at the end of each service pipe must be located avoiding conflict with other services.

Each connection 100 mm or larger shall be installed with tee and isolation gate valve on the service at the water main. The engineer may choose to add an additional valve at property line to facilitate testing and tie-in procedures.

Services and curb stops must have a minimum depth of cover of 1.0 m and curb stops must be no deeper than 2.0 m. Valve boxes and 150 mm riser pipes shall be used for curb stops greater than 50 mm diameter.

3 SANITARY

CONTENTS

3	SANITARY	3-1
3.1	General.....	3-2
3.2	Per Capita Flow.....	3-2
3.3	Peaking Factor.....	3-3
3.4	Infiltration.....	3-3
3.5	Design Flow.....	3-4
3.6	Pipe Flow Formulas.....	3-4
3.7	Flow Velocities.....	3-4
3.8	Alignment.....	3-5
3.9	Minimum Pipe Diameter.....	3-5
3.10	Minimum Grade.....	3-6
3.11	Curved Sewers.....	3-6
3.12	Depth.....	3-6
3.13	Manholes.....	3-6
3.14	Odour Control.....	3-8
3.15	Service Connections.....	3-9
3.16	Lift Stations.....	3-10
3.17	Force Main.....	3-16
3.18	Noise Control.....	3-17
3.19	On-site Sewage Disposal (Septic systems).....	3-17
3.20	Low Pressure Sewers.....	3-17

3.1 General

These guidelines are not intended to be a substitute for sound engineering practices. Sanitary sewer system designs shall be prepared under the direction of a design professional who has the appropriate experience and is registered with Engineers and Geoscientists British Columbia.

These guidelines apply to the Village sewage collection system only.

3.2 Per Capita Flow

3.2.1 Residential Flows

In absence of sanitary sewer flow data, sanitary sewer design shall be based on an average daily dry weather flow (ADWF) of 300 liters/capita/day (L/c/d), except when used for the analysis of older areas (pre-1980), where a ADWF = 420 L/c/d shall be used.

For system design in undeveloped areas, ADWF shall be estimated based on zoning as per Table 3-1:

Table 3-1 Flow Values for Undeveloped Residential Areas

Zoning	Population/ Hectare (gross)	Population/Unit
Single Family	24-30	3
Multi-Family Low	65	2
Multi-Family Medium	120 (3 Storey)	2
Multi-Family High	320-960 (4-12 Storey)	2
Mobile Home	40	2

3.2.2 Non-Residential Flows

ADWF for non-residential areas should be based on specific data related to the development. In the absence of such data, use the following flow values which are based on zoning designations (Table 3-2):

Table 3-2 Flow Values for Undeveloped Non-Residential Areas

Land Use	Equivalent Population/Hectare	ADWF* (L/ha/day)
Commercial	83	25,000
Institutional	83	25,000
Industrial	83	25,000

*ADWF calculated at 300 Litres per day per capita

3.3 Peaking Factor

The peaking factor is the ratio of peak dry weather flow (PDWF) to the average dry weather flow (ADWF). Where possible, the peaking factor should be based on locally recorded flow data from similar developments. It is recommended that if possible, residential equivalents not be used but that each customer type calculates peak flows independently. When using hydraulic modelling software, it is recommended that diurnal patterns be used that reflect varying time of day flows from each customer class. In the absence of such data, the peaking factor is to be calculated using the design residential population and non-residential equivalent population, with the formula indicated below:

The ADWF is multiplied by the Peaking Factor to determine PDWF. The Peaking Factor (PF) is calculated as follows:

$$PF = f \left(1 + \frac{14}{4 + \sqrt{P}} \right)$$

where: P = Population in Thousands

f = Reduction factor, applied as follows:

- New residential areas = 0.75
- Old residential areas = 0.85
- Commercial and Industrial area = 1.00

3.4 Infiltration

Design flow must include an infiltration allowance to cover groundwater infiltration and system inflows. For urban, suburban or commercial areas, the allowance should be based on the gross tributary area and the following:

- New system with pipes above groundwater table: 0.06 L/s/ha (5,184 L/d/ha)
- Old system (pre-1980) and/or pipes below groundwater table: 0.17 L/s/ha (14,688 L/d/ha)

The above values are based on systems where roof leaders, foundation drains and parking drains are not connected to the sanitary sewer.

For older systems it is recommended that the above value be confirmed with flow monitoring since, in some systems, this value can be substantially higher.

For low density areas with large lots (>90 m frontage), or spaces between developed areas, the infiltration allowance should be based on the total sewer system pipe sizes and lengths, including sewer mains, service connections and building sewers, and the following:

- New system with pipes above groundwater table: 0.45 L/mm dia./100m length/hour
- Old system (pre-1980) and/or pipes below groundwater table: 1.0 L/mm dia./100m length/hour

3.5 Design Flow

Design flow $Q_{\text{Design}} = \text{ADWF (from all sources)} \times \text{PF} + \text{Infiltration Allowance.}$

3.6 Pipe Flow Formulas

For Gravity Sewers use Manning's Formula: $Q = \frac{AR^{0.667}S^{0.5}}{n}$

Where:

- Q = Design flow in m^3/s
- A = Cross sectional area in m^2
- R = Hydraulic radius (area/wetted perimeter) in m
- n = Roughness coefficient, where:
nconcrete = 0.013
nPVC = 0.011

For Sewage Force Mains use Hazen-Williams formula: $Q = \frac{CD^{2.63}S^{0.54}}{278,780}$

Where:

- Q = Rate of flow in L/s
- D = Internal pipe dia. in mm
- S = Slope of hydraulic grade line in m/m
- C = Friction coefficient = 120 for all pipe

3.7 Flow Velocities

Minimum design velocities:

- Gravity sewers: 0.60 m/s
- Force mains: 0.75 m/s

Where steep grades result in velocities exceeding 6.0 m/s, sewer design must consider measures to prevent pipe and manhole erosion, movement and the effects of dynamic loading. Pipe anchors shall be installed on steeper grades in accordance with MMCD standard drawings.

3.8 Alignment

Sanitary sewers to be located within roadways, preferably along the centreline, as shown in the applicable standard road cross-section drawings. Manhole covers to be located outside of wheel path.

For curved roads and alignments, except as indicated for Curved Sewers (Section 3.11) where approved by the Village, pipe alignment to be at a parallel offset with an established road right-of-way or property line. Horizontal and vertical alignments must be straight lines between manholes for gravity sewers, and between defined deflection points for force mains.

Where the main may exceed 4.5 m depth of cover to provide a gravity service, the Village may permit a design based on sewer pumps. Ideally, main floors should be designed for gravity service.

Where a sewer crosses private land, right-of-way requirements are as indicated in Section 1.1.3. When the sanitary sewer is required to cross private land(s), the width must be suitable to accommodate excavations based on WCB regulations for side slopes.

When a sanitary sewer is located within a statutory right-of-way and appurtenances which require maintenance are located within the right-of-way, the Owner must ensure that maintenance access is available. For large structures or structures requiring an enhanced maintenance level, an access route adequate to support maintenance vehicles is to be provided. The surface of the route may be gravel, concrete or asphalt depending on the location and the context of the site.

Clearance from water mains as detailed in Section 1.1.4.

Common trench with storm sewer per Section 1.1.5 may be approved at the discretion of the Village.

3.9 Minimum Pipe Diameter

- Residential: Sanitary sewer main must be 200 mm in diameter except for the upstream section where future extension is not possible, in which case 150 mm is acceptable provided it has a grade of 1% or greater.
- Commercial and Industrial: Sanitary sewer main must be 250 mm in diameter except for the upstream section where future extension is not possible, in which case 200 mm is acceptable provided it has a grade of 0.6% or greater.
- Service connections: 100 mm.
- Sewage force mains: 100 mm.

Gravity sewer mains must be designed so that the sewer flow does not exceed $d/D = 0.67$ for pipe diameters of 250 mm and less, or $d/D=0.75$ for pipe diameters greater than 250 mm. (where d =flow depth and D =pipe diameter).

3.10 Minimum Grade

Minimum grades of gravity sewers are as required to obtain the minimum velocity of 0.60 m/s. If the calculated design flow is not expected to produce a velocity of at least 0.6 m/s., then the minimum grade shall be calculated based on the pipe flowing 35% full at a theoretical velocity of 0.6 m/s.

Force main must be designed with a rising grade of minimum 0.1% whenever possible to minimize high points in the system. Where a high point is unavoidable, air release valve shall be installed at that location.

3.11 Curved Sewers

Where permitted by the Village, horizontal and vertical curves may be formed using pipe joint deflections as follows (no deflection along the pipe barrel permitted):

- Minimum radius = 60 m
- Constant radius throughout curve and constant offset to road centreline where possible
- Joint deflection not to exceed 75% of maximum recommended by pipe manufacturer
- Minimum design velocity = 0.9 m/s
- Only one horizontal and/or vertical curve allowed between manholes
- Curve locations to be accurately recorded on record drawings

3.12 Depth

Sewers should be of sufficient depth to:

- Permit gravity service connections to MBE on both sides of the road
- The minimum depth of the sewer main must be 1.0m
- Allow for future extension(s) to properly service all of the upstream tributary lands for ultimate development
- Clear other underground utilities.
- Maximum cover depth: 4.5 m, except under special circumstances and with the Village's approval.

3.13 Manholes

3.13.1 Locations

Manholes are required at the following locations:

- All changes in pipe size

- All changes in grade
- Upstream and downstream end of curvilinear sewer mains
- All intersecting sewers
- Upstream end of every sewer line
- Every future pipe intersection
- All terminal sections
- 150 m maximum spacing

Sanitary manhole rim elevation shall not be located in a low point that may be subject to ponding or storm water infiltration and shall be designed to be:

- Above the adjacent storm manhole rim and catch basin elevations.
- Above the surrounding ground elevation when the manhole is located off road to prevent inflow from ponding.
- Manholes shall be designed and installed to meet the Worker's Compensation Board of BC Occupational Health and Safety (OHS) Regulation.

Sanitary manholes are to be benched. Manhole bases shall be constructed to a 150mm thickness for pipe sizes up to 450mm inner diameter. For pipes larger than 450mm inner diameter, a 200mm thick base is required. Where the base and barrels meet, grouting is required.

3.13.2 Hydraulic Details

Crown elevations of inlet sewers not lower than crown elevation of outlet sewer. When connecting a collector sewer main to a trunk sewer 300 mm or greater, the invert of the collector main must not connect lower than 0.75D (³/₄ of the pipe diameter).

Minimum drop in invert elevations across manholes:

- Straight run: 10 mm drop
- Deflections up to 45-degrees: 25 mm drop
- Deflections 45-degrees to 90-degrees: 50 mm drop.

3.13.3 Drop Manhole Structures

Drop manhole and ramp structures should be avoided where possible by steepening inlet sewers. Where necessary, provide drop structures as follows (Table 3-3):

Table 3-3 Drop Structures

Invert Difference	Structure
Up to 0.45 m	Inside Ramp
0.45 to 0.90 m	Outside Ramp

Greater than 0.90 m	Outside Drop*
*Inside drop may be used if specifically approved by the Village.	

Table 3-3 Notes:

- Drop manholes and outside ramps must be installed in accordance with standard drawings.
- The maximum deflection angle created in a junction is 90-degrees.
- Force main discharges should be directed into the receiving manhole outflow pipe. Manhole benching should be extended a minimum 200 mm above the force main crown. If a manhole drop cannot be avoided, an inside drop pipe is required as approved by the Village.

3.13.4 Through Manhole Structures

Where a small pipe joins a larger pipe the crown elevation of the smaller pipe shall be at or above the larger pipe. All pipes shall discharge in the same direction as that of the sewer flow. No drop-in invert is required for a through manhole where the sewer mains are of the same size. A 30 mm drop in invert for alignment deflections up to 45-degrees and a 60 mm drop in invert for alignment deflections from 45-degrees to 90-degrees shall be provided.

3.13.5 Temporary Clean-Outs

Temporary clean-outs may be provided at terminal sections of a main provided that all of the following conditions are met:

- Future extension of the main is proposed or anticipated within 3-years
- The length of sewer to the downstream manhole does not exceed 45.0 m
- The depth of the pipe does not exceed 2.0 m at the terminal point

3.14 Odour Control

Odour control must be considered in all sanitary sewer systems designs.

The following criteria must be met in all sanitary sewer systems:

- Dissolved sulphide maximum limit at any point in the system is to be 0.5 mg/l
- Odour Criteria:
 - At 10 m from any gravity main, force main, manhole and lift station or other sewer facility (summer conditions, winds between 2-10 km/h), 1.0 odour units
 - Where sewer facilities are close to houses, parks or walkways, 0.0 odour units
- Analysis for Odour and sulphides may be required
- Odour Control provision shall be designed to accommodate both at 25% build-out and at 100% build-out

- All lift station designs to include odour control or the provision for future odour control facilities

When selecting the appropriate odour control technologies, the designer shall consider operating variables such as flow rates, power and consumables. It should be recognized that estimating the pre-treatment hydrogen sulfide gas concentrations is critical in evaluating the various technologies. All Odour Control treatment designs to be approved by the Village

3.15 Service Connections

Every legal lot and each unit of a residential duplex shall be provided with a separate service connection.

Lots are allowed one service connection per property. In special circumstances where the servicing of all buildings on existing industrial or commercial properties is not feasible, two services may be permitted if authorized by the Village.

Servicing from roadways is required unless a depth of greater than 4.5 m would be required to provide gravity service. Rear yard sewers are to be avoided, and advance approval is required from the Village.

Service connections shall not be extended at an angle that exceeds 45-degrees from perpendicular to the main, and in no case shall a service connection be placed so that it extends in front of any property other than the one being serviced.

Unless otherwise approved by the Village, connections are to service all plumbing by gravity. Building elevations should be established accordingly. Pumped connections may be permitted if approved by the Village prior to sewer design. Pumped connections shall be considered as an option to eliminate mains in rear yard rights-of-way.

Relocating a service connection requires the location and removal of the existing service to the main, cutting and capping the existing servicing at the main and removal of any inspection chambers.

3.15.1 Size

- Pipe size is to accommodate peak design flow.
- Minimum pipe size is 100 mm diameter for residential services and 150 mm for all other services.

3.15.2 Location and Depth

For undeveloped lots, service connections shall be located as shown on the standard drawings and shall extend 2m into the property.

The minimum depth of a service at the property line must be 1.0 m provided that gravity service to the Minimum Building Elevation (MBE) is available.

Where a building structure exists on a parcel of land, service connections shall be installed at a location acceptable to the property owner and approved by the Village.

3.15.3 Grade

Minimum grade from property line to sewer main:

- 100 mm diameter pipe: 2.0%
- 150 mm diameter pipe: 1.0%
- Larger sizes: Grade based on minimum velocity of 0.75 m/s.

3.15.4 Main Connections

The service connection centreline must not be below the sewer main centreline.

For service connections 150 mm or less:

- To new mains, use standard wye fittings for connections
- To existing mains, use wye saddles or, where approved by the Village, insertable tees may be used
- Sanitary sewer service connections are not to be made into manholes. Where no alternative exists and approval is granted by the Village the connection may be made provided that: The connection is not oriented against the flow in the main
- The connection enters the manhole, so the service invert is no lower than the sewer main crown
- Manhole hydraulic requirements are met

Manholes are required at the main on service connections larger than 150 mm.

3.15.5 Details

Inspection chambers (IC) are required for all service connections. Service boxes are to be installed on every inspection chamber as per Standard Drawings.

Inspection manholes are required on all industrial connections. Inspection manholes will be required for commercial connections at the discretion of the Village. Inspection manholes shall be installed on public property as close to property line as practical.

The maximum length of any service connection is 30 m. Connections exceeding 30 m in length will be treated as mains.

3.16 Lift Stations

The use of sanitary lift stations should be avoided. Where necessary, any proposed lift stations must receive prior approval from the Village. Sanitary lift stations must be located within a right-of-way outside the required road dedication.

This section covers both dry well and submersible sewage lift stations. Larger capacity sewage lift stations or lift stations with special design or siting requirements may require additional assessment and review of criteria.

Preliminary design must be approved by the Village before detailed design proceeds.

3.16.1 Preliminary Design Requirements

System layout: Select location(s) to minimize the number of sewage lift stations and avoid lift stations wherever practical.

Capacity: The lift station must be designed to handle the ultimate flows of the designated catchment. Design must consider short, intermediate and long-term future flows.

Flood Elevations: All control panels, kiosks, and generators must be above the FCL as outlined in the Fraser Valley Regional District Bylaw No. 0681. The specified FCL for Harrison Lake is 14.55 metres using the Canadian Geodetic Vertical Datum of 1928 (CGVD28). Careful use of other vertical datum (i.e. CGVD2013, NAD83, WGS84, etc.) is necessary; elevations will need to be converted carefully. The project vertical datum and converted FCL shall be shown on preliminary and detailed design drawings. Additionally, Station uplift design must be based on maximum load level.

Location and Layout: The location and layout of a lift station, as requested by the Village, may require the following basic design considerations:

- Type of station and impact on neighbours
- Construction dewatering requirements
- Access for construction
- Access for maintenance
- Aesthetics, noise, odour control and landscaping requirements
- Security against vandalism and theft
- Flood elevations. Station uplift design must be based on maximum load level
- Proximity of receiving sewers, water mains, and adequate power supply
- Minimizing energy requirements
- Standby power and its compatibility
- Soils. Geotechnical investigations must be undertaken prior to site approval
- Convenience of operation and maintenance
- Safety for operators and public
- Capital and operation and maintenance costs
- Radio Path assessment on existing and proposed building line of sight
- Off street Parking (5 m x 7 m) shall be provided for pump maintenance
- Fenced perimeter with 1.8 m high black chain link fencing. Fencing to MMCD standards
- Above ground valve chamber with no ladder or platform requirement for maintenance access

3.16.2 Design Features

Lift stations must be designed with a minimum of two pumps, each capable of handling the maximum flow condition. A mixer should be provided, or one pump equipped with an automatic flush valve.

Where the design flow exceeds the capacity of a single, commonly available pump, use three or more pumps with capacities such that there is always one pump available for standby.

3.16.2.1 Pump requirements:

- Pump selection must be approved by the Village before detailed design proceeds. Flygt pumps are preferred
- Capable of passing solids up to 75 mm in size
- Equipped with appropriately rated stainless steel chain and connecting rings
- Equipped with hour meters
- Easily removed for maintenance without having to enter the sump
- Maximum motor speed: 1,750 RPM
- Explosion proof
- Operate on a 347/600-volt electrical source (pump motors between 5 hp and 75 hp (max) and to be 600-volt 3 phase type)
- Able to operate alternately and independently of each other
- Able to meet maximum flow condition with one pump in failure mode
- Designed so that each motor does not cycle more than four times in one hour under normal operating conditions.
- All pumps must be factory tested prior to installation
- Wet well storage shall be sized assuming pump is fully submersed and will accommodate design flow with no storage in the pipe network
- All internal piping and fittings shall be 316 stainless steel (Victaulic style)
- Pump start water level to be set above the top of the pump casing to prevent buildup on pump and reduce level monitoring issues

3.16.2.2 Motor cables, power cables, etc., must be continuous from within the pump station to within the kiosk unless an adequate exterior pull pit and junction box is installed.

3.16.2.3 Levels to be controlled by ultrasonic level transmitter with emergency high- and low-level floats. A radar level transmitter is required when lift station service is in an area that produces large amounts of "foam" or "steam". Level

transmitters to be accessible at the top of the wet well to be serviced without entering into the lift station.

- 3.16.2.4 All auxiliary equipment and control panels must be mounted in a suitable kiosk adjacent to the station. The kiosk must be located a minimum of 3.0 m from the station lid.
- 3.16.2.5 The control kiosk must be designed to contain all control and telemetry equipment on the front panel and all power equipment on the rear panel and security system.
- 3.16.2.6 Check valves must be ball lift check valves. All valving to be installed in an above ground kiosk.
- 3.16.2.7 All stations require an explosion-proof exhaust fan which can be activated by manual switch, and which meets WCB requirements for ventilation in a confined space.
- 3.16.2.8 The entrances to all stations must be waterproof and be provided with a suitable lock. The access must be a minimum 900 mm x 900 mm in size. The access hatch shall have:
 - An aluminum 1/4" tread plate
 - A perimeter drain
 - A perimeter sealing gasket
 - A slam lock with an aluminum removable sealing plug and opening tool
 - A flush lift handle
 - A gas spring assist cylinder
 - A 90-degree hold open arm
 - A flush fitting padlock

The hatch must be reinforced for 1,465 kgs/m² (300 lbs./sq. ft.). All fasteners to be made of 316 stainless steel

The entrance must be above ground level where feasible but, in no case, more than 300 mm above the ground

- 3.16.2.9 All wiring must be explosion-proof, Class 1, Division 2, and electrical design and installation is subject to the acceptance of the Provincial Safety Inspector. Metal stations must be protected by impressed current cathodic protection. All stations must provide an automatic generator for standby

power in case of power failure. Provision for a telemetry system must be included for connection into the Village's Telemetry System.

- 3.16.2.10 All equipment must be CSA approved and have at least a one-year guarantee for parts and labour.
- 3.16.2.11 Designer is to provide copies of Operating and Maintenance Manuals (see Section 1.1.8).
- 3.16.2.12 Wet well to have above ground valve chamber that houses the ball check and isolation plug valves for each pump as well as the air relief valve and flow meter. Valve chamber to have at a minimum 50 mm of insulation, 1,000W intrinsically safe baseboard heater, door seals, floor drain back to the wet well with p-trap and the air relief drain ports piped to the Valve Chamber floor drain. A plug valve is required on the influent line and on each pump discharge. The valves must be outside the station and be complete with square operating nut and nelson box. Gear box on plug valves in the ground to be designed for submersion.

Mixer to be provided only when required for the purposes of odour control, automatic flush valves are required.
- 3.16.2.13 If a lift station is authorized, by the Village, to be constructed in an area that may be subject to vehicle loads, the roof and cover of the pump station must be designed to withstand a loading of H-20 (highways standard). Roof design to also allow for fall arrest assembly on the roof (2X's the max arresting force, typically 1,800 lbs).
- 3.16.2.14 Provision(s) must be made for standby pumping from an external source. An adaptor flange ("Camlock") complete with a quick coupling and lockable cap will be required.
- 3.16.2.15 The area around the station and all associated equipment or building must be surfaced with 19mm minus road gravels. The size of the area to be determined by the requirements for maintenance.
- 3.16.2.16 Stations to be fiberglass unless otherwise approved by the Village. The surfaces of all steel components and fibreglass stations must receive at least

two coats of two component white epoxy enamel. All steel piping and components to be 316 stainless steel.

- 3.16.2.17 The wet well bottom must be sloped to direct all solids into the pump suction. The influent line must be located tangent to the wet well to encourage scouring of the wet well.
- 3.16.2.18 The station shall be complete with an Uninterruptable Power Supply (UPS) to serve all alarms and controls.
- 3.16.2.19 Separate starter enclosures must be provided for each pump.
- 3.16.2.20 PLC control to be based on Village requirements.
- 3.16.2.21 Station communication to be provided via radio transmission compliant with the Village telemetry system, and an antenna must be installed on a suitable mast or pole to ensure reliable transmission.
- 3.16.2.22 An hour meter must be built into the panel for each pump.
- 3.16.2.23 An amp meter must be provided for each pump.
- 3.16.2.24 Minimum storage between the high-level alarm and the start of overflow under the more critical of:
- Minimum 1 hour in wet well at average wet weather flow
 - Minimum 1 hour in wet well and influent pipes at peak wet weather flow
- Ensure operating level is above the top of the pumps to keep the pumps submerged (Minimum 1 m separation between the inlet pipe invert and pump stop level).
- 3.16.2.25 Station to have a magnetic flow meter located in above ground valve chamber.
- 3.16.2.26 Station to allow removal of pumps using hoist truck with 1.8 m (6') boom.
- 3.16.2.27 Perimeter fencing is to be provided. The fence must be made of black chain link and installed with privacy slats. Fence to be minimum 1.8 m high with minimum 5 m wide opening for vac truck access.
- 3.16.2.28 Landscaping, acceptable to the Village, is to be provided including irrigation.
- 3.16.2.29 Noise control may be required when criteria in Section 2.16 is exceeded.
- 3.16.2.30 Odour control may be required when criteria in Section 2.17 is exceeded.
- 3.16.2.31 Minimum barrel size must be 2,440 mm in diameter.

3.17 Force Main

As part of the lift station design, the following criteria must be noted in the design of force main systems: Design computations for force mains must be made using a 'C' factor of 120 (for PVC pipe) and then re-calculating the system curve using a 'C' factor of 145 to ensure adequate motor horsepower and pump characteristics. Show pump and system curves on design drawings.

3.17.1 Velocity

At the lowest pump delivery rate anticipated to occur at least once per day, a minimum cleansing velocity of 0.75 m/s should be maintained. Maximum velocity should not exceed 4.0 m/s.

3.17.2 Air Relief Valve

An automatic air relief valve must be placed at high points in the force main to prevent air locking when the difference in elevation between the invert of the summit and the invert of the valley is greater than the diameter of the pipe. The air relief valve must be located in a chamber, complete with adequate and environmentally safe drainage and odour control, unless a suitable injected odour control agent is used at the Lift Station. Air valve must be vented and drained into the gravity sanitary sewer system at a manhole, where possible.

3.17.3 Termination

Force mains should enter the gravity sewer system so that the force main invert is not more than 200 mm above the crown of the pipe in the receiving manhole. A smooth, turbulent free transition must be incorporated. If the receiving manhole design does not allow this, then a manhole drop structure in accordance with the standard drawings is required.

3.17.4 Size

The minimum size for force mains is 100 mm diameter.

3.17.5 Materials

Force mains must generally meet the standards specified for water mains and shall adapt to local conditions, such as character of wastes, soil characteristics, exceptionally heavy external loadings, abrasion and similar problems. The minimum acceptable class of pipe shall be PVC DR-25 or HDPE DR-18.

There are specific requirements for force mains that may supersede water main standards, as follows:

- Force main pipe must be identifiably different than water main pipe.
- Valves used on force mains, pigging ports or cleanouts shall be lubricated full port plug valves size on size sufficient for long term use in a corrosive environment. Plug valve gear boxes installed in the ground must be designed for submersion conditions.

3.17.6 Loads and Transient Pressures

All force mains must be designed to prevent damage from superimposed loads. Must also be designed to prevent damage from water hammer or column separation phenomena. Transient surge and cyclic surge analysis must provide at least a 75-year life of the pipe.

3.17.7 Corrosion and Odour

Corrosion and odour control is required when limited daytime flows, or long force main lengths cause the pumped sewage to remain in the force main for longer than 45 minutes.

3.17.8 Pigging Port

A "size on size" pigging port that is convenient for the Village Operations to use and maintain must be incorporated in the force main outside of the Lift Station.

3.18 Noise Control

Noise levels for facilities must not exceed 65 dB at property line or 20 m away whichever is closer.

3.19 On-site Sewage Disposal (Septic systems)

On-site sewage disposal systems will not be permitted within the Village.

3.20 Low Pressure Sewers

Low pressure sanitary sewer systems servicing a group of properties will not be permitted.

4 DRAINAGE

CONTENTS

4	DRAINAGE	4-1
4.1	General	4-2
4.2	Drainage System Service Level	4-2
4.3	Off-Site System Capacity	4-3
4.4	Rainwater Management Principles	4-3
4.5	Stormwater Management Plan	4-3
4.6	Ground Water Recharge Systems	4-4
4.7	Performance Targets	4-4
4.8	Stormwater System Design Criteria	4-6
4.9	Run-Off Analysis	4-6
4.10	Rainfall Capture and Source Control – Retention System Design	4-11
4.11	Outlet Controls	4-14
4.12	Water Quality Treatment	4-14
4.13	Natural Watercourses	4-15
4.14	Controlled Release and Conveyance – Minor System Design	4-16
4.15	Storm Mains	4-22
4.16	Flood Management - Major System Design (Detention)	4-29
4.17	Erosion and Sedimentation Control	4-35

4.1 General

This section provides specific criteria and guidelines for designing drainage systems that meet the Village performance targets for stormwater retention, detention, and conveyance.

These guidelines are not intended to be a substitute for sound engineering knowledge and experience. Drainage designs should be prepared under the direction of a design professional who has the appropriate experience and is registered with the Engineers and Geoscientists of British Columbia.

The guidelines cover only minimum requirements.

4.2 Drainage System Service Level

The drainage design criteria standardize the procedures for designing rainwater collection, management and conveyance facilities in the Village. All drainage systems shall be designed with consideration for water quality and quantity, public safety, regulatory requirements, maintenance, economic benefits, and the natural environment.

The following requirements shall be met by developments in the Village:

- All proposed drainage systems shall drain to existing, adequate drainage systems.
- The drainage system criteria are focused on peak reduction strategies (i.e. storm water detention) that incorporate volume reduction and improved water quality are encouraged.
- Designers shall consult with the Village before or during preliminary design to determine if infiltration or underground storage tanks will be approved.
- Drainage systems shall consist of three components: the retention system, the conveyance system, and the Flood Management System designed into a coordinated system using storm water management principles.
- Designers shall consult with the Village to determine what existing information may be of assistance to them.
- Treatment of runoff to improve water quality is required for all non-covered paved parking, storage or workspace areas in multi-family, industrial, commercial and institutional developments.
- Erosion and sediment control is required for all developments or Works and Services discharging runoff into drainage systems and natural watercourses.
- A minimum 300 mm thick layer of absorbent soil – a growing medium that balances water storage capacity, saturated hydraulic conductivity and nutrient and organic components – is required for all lawn and soft-landscape areas.
- All drainage systems shall be located within a roadway or a registered statutory right-of-way. When a drainage system is proposed to be connected to an existing, adequate drainage system that is not protected as above, efforts by the Owner may be required to acquire necessary statutory right-of-way at the

discretion of the Village. The cost for securing this protection shall be borne by the Owner.

4.3 Off-Site System Capacity

As required by the Village, the Owner shall analyze all downstream piped and overland drainage systems to determine if they are adequate for the projected increase in runoff created by any development.

Existing drainage systems which are undersized or inadequate to accept additional drainage flow shall be upgraded to accommodate the proposed flows at the Owner's expense, or the detention system shall be enlarged to detain the major flow.

4.4 Rainwater Management Principles

Rainwater Management includes the planning, analysis of storm runoff from rainfall events on a site, neighbourhood, and watershed level.

The design of the drainage system shall incorporate techniques such as absorbent soils, rain gardens, bio-swales, storm detention, lot grading, rain interception, subsurface disposal, erosion control, and other acceptable methods to mitigate the runoff impacts due to Development. Infiltration methods are discouraged, designers shall consult the Village before or during preliminary design if an infiltration system is proposed. Designers may be required to apply high factors of safety to infiltration calculations at the Village's discretion. A comprehensive Stormwater Management Plan is required for all developments of greater than 0.5 ha in size except rural or agricultural developments unless otherwise directed by the Village.

The Stormwater Management Plan shall include all major elements of the drainage system, including sub-catchment plans, trapped low plans, storage and flow control facilities, lot grading (including pre and post-developments ground elevations), major flood path routing, and all other appropriate information pertinent to the design.

4.5 Stormwater Management Plan

Stormwater runoff generated from within the subdivision shall be routed through a stormwater management facility as required to regulate the rate of outflow prior to discharge, unless otherwise approved by the Village.

Stormwater management facilities shall be designed in accordance with this design standard, the "Storm Drainage Design Guidelines" prepared by the Master Municipal Construction Documents Association, and in accordance with good engineering practice.

A phased construction approach to match the expected development sequence may be acceptable upon approval by the Village, provided the requirements of this guideline are met. Temporary storm ponds and structures, without the required facilities and design components per this guideline, are not acceptable.

The Stormwater Management Plan shall be consistent with the standards outlined herein and shall:

- Identify the locations, sizes, design flows, volumes, and capacities of all existing and proposed underground and overland works.
- Identify tributary areas in the catchment which identify existing and potential land uses or current development.
- Identify trap low locations and high-water elevations for each location.
- Identify relevant sections of the Liquid Waste Management Plan.
- Identify site contours at 0.5m elevation intervals
- Identify the impact of the proposed development on the watershed.
- Identify and quantify the amount of upstream drainage entering onto the proposed development lands, including all point(s) of entry.
- Identify all existing flow channels, drainage patterns or routes, and containment areas.
- Identify the point(s) of discharge from the lands, as well as the type and calculated capacity of the receiving drainage facility(s), whether natural, man-made or a combination of both.
- Identify capacity of downstream works.
- Provide conceptual lot grading patterns.
- Provide details of required stormwater retention/detention facilities.
- Provide details of storm water quality enhancement facilities.

Confirmation that the Stormwater Management Plan standards are met shall be required from the Consulting Engineer. The Village requires submission of a copy of the Stormwater Management Plan.

4.6 Ground Water Recharge Systems

To promote interception of pollutants and reduction in downstream impacts, ground water recharge systems may be utilized as determined by a qualified professional experienced in this field and with Village approval. The use of ground water recharge systems shall not contribute to the capacity of the drainage system and the Village shall have final authority in their use.

Mains shall be sized according to the required capacity taking 0% of the groundwater recharge capability into consideration. The groundwater recharge component must still be calculated and justified by a registered professional hydrogeologist/engineer experienced in this field. Minimum sizes of mains must still be utilized.

4.7 Performance Targets

4.7.1 General

All new development projects in the Village must incorporate stormwater management systems that meet the following Performance Targets:

- Rainfall Capture (retention) - Captures the first 30 mm (the six-month rainfall event) of rainfall per day and restores it to natural hydrologic pathways by promoting absorption, surface storage, evapo-transpiration, rain interception, or rainwater reuse
- Runoff Control (conveyance) – Can safely convey the first 60 mm (up to the 10-year rainfall event) of rainfall per day and release to drainage system or watercourses, detaining when necessary to release at the predevelopment or natural interflow release rate
- Flood Risk Management (detention) - Ensure that the stormwater plan can safely convey storms greater than 60 mm (up to a 100-year rainfall event)

A stormwater system on a development site that meets the above targets would include:

- Source controls building lots and roads that overflows to a detention facility about six to eight times per year
- A detention facility (or facilities) that would overflow once per year, on average
- A stormwater conveyance system that can safely convey runoff from extreme storms to the outlet of the development site

Table 4-1 - Drainage System Performance Targets

Drainage System Performance Targets		
Rainfall Capture	Runoff Control	Flood Risk Management
<ul style="list-style-type: none"> • Capture 300 m³ of rainfall per hectare of impervious area retain for reuse within the development site • ensure storage facilities have 'escape routes' and can fully drain between stormwater events 	<ul style="list-style-type: none"> • Provide an additional 300 m³ of detention storage per hectare of impervious area • Capable of conveying 600 m³ of rainfall per hectare • Release to storm sewers or streams at a rate of 1 L/s/ha or pre-development release rate for 1:10 year event • Provide 'escape routes' for extreme storms 	<ul style="list-style-type: none"> • Ensure that these routes are both hydraulically adequate and physically appropriate or adequate

4.7.2 Low Impact Development

Where practical, the following general principles should be considered and incorporated into the site plan to reduce runoff from frequent minor storms. Site-specific design parameters are to be developed for each site based on input from the Geotechnical Engineer, Landscape Architect, Industry Best Practice, and Village requirements.

- Soft landscaped areas to consist of deep absorbent soil. Where adjacent to roadways, subgrade protection is to be included in the design
- Underlay landscaping with sandy engineered soils
- Consideration shall be given to rainwater harvesting for onsite irrigation or re-use
- Where appropriate soil and groundwater conditions exist, and with Village approval, consider subsurface stormwater management systems for groundwater recharge
- Limit the use of grass turf / lawn landscaped areas as these areas require long term maintenance, irrigation, and fertilizer. Use natural vegetation that contributes to diverse habitat and resilient ecology
- Maintain existing vegetation, in particular trees with canopies and deep roots
- Engineer bioswales and naturalized channels for the conveyance of stormwater
- Specify permeable hard-surfacing materials such as permeable pavers for low-traffic areas where appropriate
- Utilize green roofs on buildings to reduce runoff, provide habitat, increase the insulation value, and reduce heat island effect

4.8 Stormwater System Design Criteria

Specific design criteria for drainage systems are presented in three separate sections:

Section 4.10 Rainfall Capture and Source Control - Retention System Criteria – Guides Owners through the process of designing the retention facilities to capture the first 30mm of rainfall per day. This section includes a methodology for sizing infiltration facilities and requirements for performance monitoring.

Section 4.14 Conveyance - Minor System Criteria – Introduces the principles of Minor and Major system Design and provides criteria for conveyance components of drainage systems. This section includes a methodology for site and lot grading, sizing and aligning pipes, and requirements for performance monitoring.

Section 4.16 Flood Management – Major System Criteria – Provides criteria for conveyance and detention of peak flows within development sites, and for discharge of peak flows to existing Village drainage infrastructure. Mitigates the effects of flooding.

4.9 Run-Off Analysis

4.9.1 General

Hydrologic aspects of urban drainage (peak flows, volume, and durations) directly affect the success of the design. Errors in analysis may result in under designing of facilities, oversizing them and incurring unnecessary expenditures, or both. In the interest of the public good, a conservative approach to all designs is warranted.

The hydrologic criteria needed to calculate basin runoff are rainfall, soil types, vegetation and ground cover, extent of development, and land slope and shape. It is expected that the design consultant will use criteria that is justifiable for the location of the development.

Application of computer simulation models is recommended for all analysis and detailed design; however, the rational method may be used for pre-design analysis and for detailed design of minor systems with contributing areas less than 10 ha.

The Owner shall provide the Village with all calculations pertinent to the design of the proposed conveyance system at the time design drawings are submitted. All designs shall determine and include post-development upstream flows based on the highest land use as per the Zoning Bylaw for the upstream lands. No reduction in pipe sizing for flow reductions due to the presence of upstream detention facilities is permitted unless otherwise authorized by the Village

4.9.2 Computer Simulation of Run-Off

All minor drainage system components draining areas larger than 10 ha. and all major drainage systems and storage facilities must be designed using computer modelling techniques. Alternatively, computer modelling may be used for areas smaller than those outlined above. It is necessary to utilize computer models which have the capability to generate hydrographs and which can route these hydrographs through a network of open channels, conduits and storage facilities showing volumes, hydraulic grade lines, the ability to simulate the minor and major system and their interrelation and the ability to simulate submerged and/or surcharged conditions.

Acceptable computer models are the OTTHYMO, PCSWMM or XPSWMM models. Submit alternate models for approval by the Village prior to design.

4.9.2.1 Runoff Hydrograph Method

The model used shall be based on the post-development conditions using the most current planning information. Conservative parameters shall be selected if calibration data is not available. For assessment of existing systems, the drainage model may be based on the existing conditions if no future land use changes are anticipated. The total developed tributary area should not deviate from the total natural drainage area.

It is incumbent upon the Consulting Engineer to obtain the appropriate rainfall data for the analysis and receive approval from the Village of the system and process to use. The use of Environment Canada IDF data for Agassiz, BC is recommended, other rainfall data may be used with approval from the Village.

4.9.2.2 Presentation of Modeling Results

The Consulting Engineer shall submit a drainage report including the following:

- Name and version of modeling program
- Calibration results
- Design storms and design parameters
- Schematic diagram of the model
- Drainage map showing the catchment and sub-catchment boundaries, slopes, land uses, soil conditions, trapped lows, etc.
- Input and output printouts and computer files

4.9.3 RATIONAL METHOD

The Rational Method may be used for pre-design system analysis and for detailed design of minor system components with contributing areas less than 10 ha. The Rational Method shall not be used for the design of major system components or storage facilities.

The Rational Formula is expressed as: $Q = RAIN$

Where:

- Q = Flow in (m³/s)
- R = Runoff Coefficient
- A = Drainage area in hectares (ha)
- I = Rainfall intensity in mm/hr
- N = 0.00278 - a fixed constant

Q: Is the resulting flow from the catchment or sub-catchment area

R: For designs not incorporating alternate rainwater management strategies, the Post-Development Runoff Coefficient for the Minor System shall conform to Sections 4.9.3.4 and 4.9.3.5.

A: The catchment areas shall be determined using the natural contours of the land. The Consulting Engineer shall confirm the extent of catchment areas. Village data on existing contour mapping and aerial photographs may not be accurate enough for design purposes and the Consulting Engineer shall confirm true and accurate surface elevations and contours for the design.

I: Rainfall Intensity is selected from the appropriate Intensity Duration Frequency (IDF) curve, with a duration chosen to coincide with the Time of Concentration. The Time of Concentration is the time required for run-off flow to become established and reach the design location from the furthest point within the contributing basin.

4.9.3.1 Time of Concentration

The time of concentration is the time required for water to flow from the most remote part of the catchment area or development area to the drainage element under design.

Time of concentration is computed by the following formula: $TC = Ti + Tt$

Where:

- Tc = time of concentration (minutes)
- Ti = inlet or overland flow time (minutes)
- Tt = travel time in sewers, ditches, channels or watercourses (minutes)

(Note: actual velocities in storm sewers shall be used to calculate Tc values.)

4.9.3.2 Low Density Residential Inlet/Overland Flow Time (Ti)

The inlet time is the overland flow time for run-off to enter the conveyance system. It varies with size of the catchment area and surface imperviousness. In **low density**

residential developed urban areas where paved surfaces drain directly to catch basins, an inlet time of 9 minutes shall be utilized for assessment of 10 year and smaller design storms. Inlet times for higher intensity design storm events are as follows:

Return Period	Inlet Time (min)
10	9
25	8
50	7
100	5

4.9.3.3 General Inlet/Overland Flow Time (Ti)

For all other uses and for undeveloped areas, inlet times shall be calculated as follows:

$$T_i = \frac{C_t L n}{12s^{0.5}}$$

Where:

- T_i = inlet time (minutes)
- C_t = flow travel coefficient (0.5)
- L = length of flow path (m)
- s = slope in m/m
- n = roughness coefficient:
 - 0.050 natural channels
 - 0.030 excavated ditches
 - 0.013 concrete lined channels
 - 0.013 concrete pipe
 - 0.011 PVC pipe

The maximum sheet flow path length in any undeveloped basin shall be 300 metres. The overland sheet flow time **shall not exceed 15 minutes**.

4.9.3.4 Pre-Development Runoff Coefficients

The following runoff coefficient (R values) shown on Table 4-2 shall be used in the calculation for the Rational Formula in Pre-Development Calculations:

Table 4-2 Pre-Development Runoff Coefficients

Type of Area Coefficient	Low	High	Standard
Grassland	0.15	0.30	0.20
Cultivated	0.30	0.50	0.40
Woodland	0.10	0.40	0.25
Roofs or Pavements	0.10	0.40	0.25

Table 4-2 Notes:

1. Low values are applicable to areas with high soil permeability (percolation rate of 0-15 minutes per 25mm) and gentle slopes (5% or less).
2. High values are applicable to areas with low soil permeability (percolation rate of over 30 minutes per 25mm) and steeper slopes (greater than 5%).
3. Standard values are for general application with moderate soil permeability (percolation rate of 15-30 minutes per 25mm).
4. The Consultant should verify the coefficient applicable for the area involved. A soils report may be required to verify the coefficient/s to be used.
5. The Village shall be the final authority on the coefficient to be utilized.

4.9.3.5 Post-Development Runoff Coefficients

The following runoff coefficient (R values) shown on Table 4-3 shall be used in the calculation for the Rational Formula in Post-Development Calculations:

Table 4-3 Post-Development Runoff Coefficients

Development Runoff Coefficients			
	Low	High	Standard
Low density housing	0.45	0.55	0.50
Medium density housing	0.55	0.65	0.60
High density housing	0.60	0.80	0.70
Commercial, Industrial	0.80	1.00	0.85
Institutional	0.70	1.00	0.80
Park or golf course	0.15	0.25	0.20
Churches or schools	0.60	0.85	0.75

Low values are applicable to areas with high soil permeability (percolation rate of 0-15 minutes per 25mm) and gentle slopes (5% or less).

High values are applicable to areas with low soil permeability (percolation rate of over 30 minutes per 25mm) and steeper slopes (greater than 5%).

Standard values are for general application. The Consultant should verify the coefficient applicable for the area involved. A soils report may be required to verify the coefficient/s to be used.

The Village shall be the final authority on the coefficient to be utilized.

4.9.3.6 Rainfall

It is recommended that Owners use of the rainfall intensity-duration-frequency (IDF) curve which was developed from the Atmospheric Environment Service recording station located at the Agassiz Weather Station. Use of other rainfall data requires Village approval.

4.10 Rainfall Capture and Source Control – Retention System Design

4.10.1 Level of Service

An urbanized area will have three separate and distinct drainage systems. These systems include the Retention System, the Minor System, and the Major System. The "Retention System" includes storage and on-site re-use facilities.

Owners shall provide capacity for capture of the first 30mm of rainfall per day and restore it to natural hydrologic pathways by promoting storage, evapo-transpiration, or rainwater reuse. This rainfall volume coincides with the six-month rainfall event.

4.10.2 Infiltration Facilities

Infiltration Facilities are discouraged but may be used to satisfy retention requirements for developments in the Village. The use of infiltration facilities must be justified by a registered professional hydrogeologist/engineer experienced in this field. Village approval should be verified by the designer prior to commencing **preliminary design**. Additional infiltration capacity shall not be used in the design of the Minor/Conveyance System.

The design of infiltration facilities must be supported by site-specific soils report, including percolation tests. Based on site-specific soils information, infiltration facilities shall be sized according to the methodology presented in Section 4.10.2. The final design of infiltration facilities requires certification from a Professional Geotechnical Engineer or Professional Hydrogeologist.

All infiltration facilities shall be designed with overflow pathways (can be pipes, channels, or overland flow) that connect to the conveyance system. All pipes leading into infiltration facilities (e.g. roof leaders) shall be fitted with debris catchers, trapping hoods, and cleanouts to minimize the movement of sediment and debris into the facilities. Infiltration facility sites shall be protected during construction from either compaction or sedimentation by pre-identification and fencing or other means. Inadvertent compaction shall be removed by ripping or scarifying the site prior to installation of infiltration facilities. Piezometers shall be installed for post-construction groundwater monitoring these facilities. Adequate sediment and erosion control during construction is essential to prevent clogging of infiltration facilities and their underlying soils.

4.10.2.1 Infiltration Facility Design Criteria

Figure 4-1 can be used by Owners to size any type of infiltration facility in **preliminary design**. Soil conditions govern the feasibility and affordability of using infiltration facilities to meet rainfall retention targets. It is therefore important to consider soil conditions at the

planning and preliminary design stages. Soil investigations and percolation testing on individual development sites is still needed for detailed design and final approval of infiltration facilities.

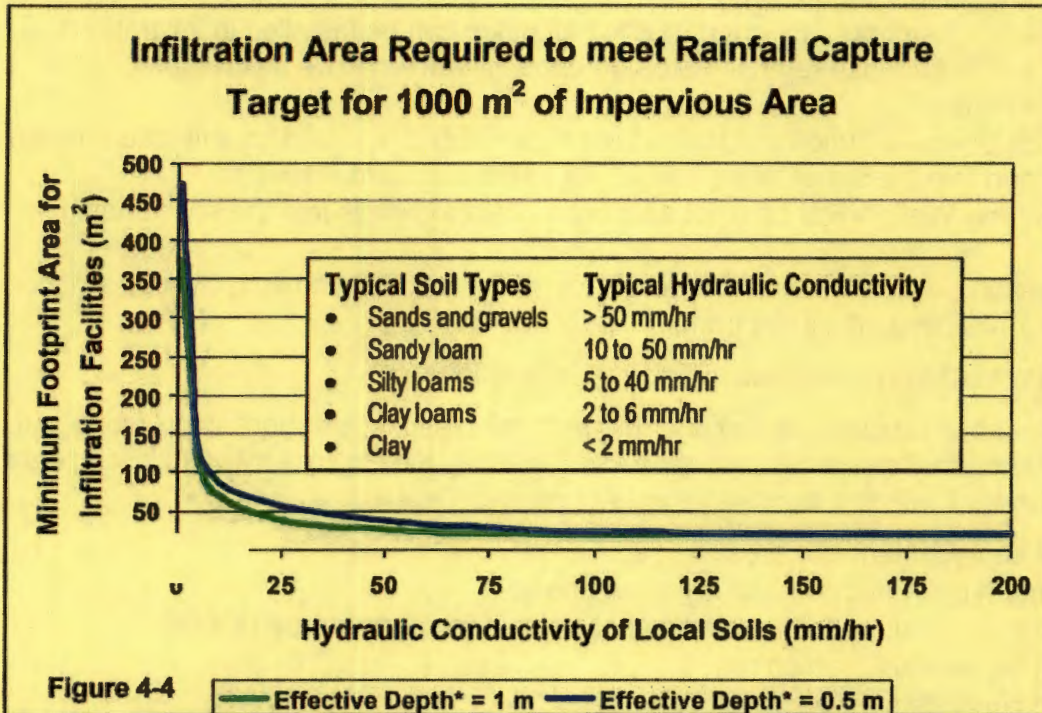

* Note: effective depth of an infiltration facility = (design depth, D) x (void space storage, VS) where,

- D = the distance from the bottom of the facility to the maximum water level/overflow level).
- VS = the ratio of the volume of water retained per unit volume of the infiltration facility.

Void space storage for different types of infiltration facilities is summarized below

- for retention ponds, VS = 1
- for soakaways (storage in drain gravel), VS = 0.33
- for infiltrator chambers (storage in sub-surface chambers & surrounding drain gravel), VS = 0.55
- for bioretention facilities (storage in absorbent soil), VS = 0.2

Figure 4-1

The following types of infiltration facilities can be used to meet the Village rainfall capture (and runoff control) targets:

- Bioretention Areas - Shallow landscaped basins that retain runoff on the surface and in a thick layer of absorbent soil. The low points of bioretention areas should be planted with plants that tolerate flooding – higher areas should be planted with streamside or upland species

- Soakaway Trenches or Pits – Trenches or pits filled with drain gravel. Absorbent landscaping can be installed over the surface, and with proper engineering, pavement (with light vehicle traffic) may be allowed on the surface (e.g. a soakaway under a driveway)
- Infiltrator Chambers - Inverted plastic half pipes can be installed in infiltration trenches to increase retention storage capacity and improve infiltration performance
- French Drains – Runoff exfiltrates from a perforated pipe into an infiltration trench and then into the surrounding soil. Refer to the standard drawings.
- Soakaway Wells – Runoff exfiltrates from screened wells into the surrounding soil
- Infiltration Swales - Consists of a surface swale (i.e. Conveyance Swale) on top of a gravel filled infiltration trench

4.10.2.2 Presentation of Infiltration Facility Calculations

The designer shall tabulate all Rational Method calculations for submission along with appropriate and other relevant information as directed by the Engineer. The following data shall be submitted with the stormwater master plan:

- Total development site area
- Minimum hydraulic conductivity of on-site soils
- Total impervious area of development parcels (excluding green roofs)
- Total impervious area on roads
- Total pervious area on development site

4.10.3 Other Source Controls

4.10.3.1 Absorbent Soils

The Infiltration Facilities design guidelines above service only impervious areas. On-site pervious areas must 'self-mitigating' (i.e. meet rainfall capture and runoff control targets). Therefore, on-site pervious areas must meet the BC Landscape Standard for medium or better landscape. To meet these criteria, soils must exhibit one of the following gradations:

- Lightest Soil:
 - 90% Sand
 - 5% Fines
 - 5% Organic Matter
- Heaviest Soil:
 - 55% Sand
 - 25% Fines
 - 20% Organic Matter
- Typical Design Soil:
 - 75% Sand
 - 15% Fines

o 10% Organic Matter

Native soil may be used, provided it meets the standards for absorbent soils or can be amended to meet all the requirements for use as a growing medium. Expertise from other sources such as Consulting Landscape Architects may be necessary, at the discretion of the Village, to ensure the growing medium meets the requirements for absorbent soils.

4.10.3.2 All Other Source Controls

Other source controls (rainwater reuse or green roofs) may be applied provided it can be shown that the Village rainfall capture criteria are met.

The design of a rainwater reuse system must be supported by a detailed water use and rainfall collection report. Low flow release to ensure adequate stream baseflow may be required in some cases. Designers shall consult with Village staff.

The design of green roofs must be supported by a drainage plan for the building envelope.

The final design of all source control facilities requires certification from a Professional Engineer.

4.11 Outlet Controls

Outlet controls for storage and detention facilities may be designed using the standard orifice and weir equation.

Orifice Equation: $Q = CA(2gh)^{0.5}$

Where:

- Q = release rate (m³/s)
- C = orifice coefficient
- A = area of orifice (m²)
- g = gravitational acceleration (9.81 m/s²)
- h = net head on orifice (m)

Weir Equation: $Q = CLH^{1.5}$

Where:

- Q = release rate (m³/s)
- C = weir coefficient
- L = effective length of weir crest (m)
- H = net head on weir crest (m)

Design of inlet and outlet structures is to include consideration of energy dissipation and erosion control. Safety grates are required over all inlet and outlet openings larger than 300mm. Locks for access hatches are required.

4.12 Water Quality Treatment

Water quality treatment is required for frequently occurring events. All flows up to 50% of the 2-year (1-hour duration) post-development flow must be routed through some form of

water quality treatment facility utilizing "best management practices" to remove suspended solids and floatables. The facility can be an in-ground structure which passes flow through or an above ground facility such as a treatment wetland. Wetlands can be incorporated into larger stormwater management facilities for the attenuation of large events.

Allowable discharge criteria must meet pre-development flow rates or acceptable discharge into watercourse identified in section 4.13. Any form of water quality treatment must be designed to allow for future maintenance activities associated with the removal of the collected material and access to incoming and/or outgoing piping.

Flows generated from rainfall events greater than this can be discharged directly to a receiving body of water provided the required minor and major systems exist and approval from the Village and the Ministry of Environment is obtained.

Quality treatment facilities include:

- Biofiltration Swales and Constructed Wetlands
- Oil and Grit Separators
- Oil/Water Separators
- Erosion and Sediment Control

4.13 Natural Watercourses

Natural watercourses may be integral components of the drainage system. The Consulting Engineer shall refer to the "Land Development Guidelines for the Protection of Aquatic Habitat" issued by the Ministry of Environment Lands and Parks and Department of Fisheries and Oceans, when proposing developments near natural watercourses like the Miami River and Harrison Lake.

Works in set-back areas and discharge to creeks, streams, and watercourse is subject to federal and provincial authority approvals. The Owner shall retain the services of a qualified environmental professional (QEP) to complete as required studies and obtain any necessary permits and approvals prior to construction.

Any development of lands shall be undertaken and completed in such a way that prevents erosion either by wind or rainfall or sediment or other deleterious substances from entering the aquifer or Village drainage systems and watercourses.

Expertise from other sources such as erosion and sediment control specialists, environmental consultant(s) or Engineers may be necessary, at the discretion of the Village, to ensure adequate design, especially in sensitive areas.

Where drainage discharge enters a natural watercourse, the Ministry of Water, Land and Air Protection generally requires adequate erosion protection and maximum velocities. Outfalls shall be constructed to meet requirements of Section 4.16.2.2.

All outfalls shall limit flow to natural water courses to 1 L/s/ha or pre-development release rates.

Riprap Design shall be in accordance with the "Riprap Design and Construction Guide" published by the Public Safety Section of the Water Management Branch, Province of British Columbia Ministry of Environment, Lands and Parks.

4.14 Controlled Release and Conveyance – Minor System Design

4.14.1 Service Level

An urbanized area will have three separate and distinct drainage systems. These included the Retention System, the Minor System, and the Major System. The "Minor System" is made up of street gutters, catch basin inlets and the network of underground pipes and facilities associated with the collection, conveyance and water quality treatment of minor, or frequently occurring rainfall events.

The "Minor System" shall provide an additional 300 m³ of detention storage per hectare of impervious area and release to storm sewers or streams at a rate of 1 L/s/ha or pre-development release rate. All detention storage facilities shall provide 'escape routes' for extreme storms.

The storm mains shall be designed for free-flow conditions for the 1:10 year storm (the rainfall that has a 10% probability of occurrence in any given year). The interception capacity of the system of street gutters and catch basins must be compatible with the design capacity of the storm mains. Developments are required to provide water quality treatment for flows up to 50% of the 2-year event.

The Minor System shall be designed to prevent flooding and property damage and minimize public inconvenience caused by rainfall events with a return period of 1 in 10 years. The runoff from a 1 in 10-year rainfall event is referred to as the "Minor Flow".

The Minor System consists of underground conduits, culverts, open channels, water courses and storage facilities designed to convey or detain runoff of frequent storm events.

Storage facilities include detention/retention ponds, bioretention areas, soakaway trenches or pits, infiltration chambers, soakaway wells, infiltration, and other methods which reduce the rate of runoff into the downstream drainage system. For criteria used in the design of infiltration facilities, see section 3.6.2.

4.14.2 Site and Lot Grading

Proper lot grading is the first step towards a well-planned minor or major drainage system. The goal of the lot grading shall be to protect private property and critical infrastructure by ensuring that water flows away from the buildings and into a municipal drainage system. Where applicable, site grading shall also be used to protect groundwater supply wells

4.14.2.1 Site Grading

The following criteria shall be used:

- Each lot should be graded to drain to the municipal storm drainage system, independently of adjacent lots where possible. Generally, stormwater discharge to adjacent private property is not acceptable.
- Flow from lots shall always have an escape route to a public right-of-way. The lot-grading plan shall develop a proper balance between the road and gutter elevations, proposed building elevations, surrounding development and existing topography.
- Areas around buildings shall be graded away from the foundations to prevent flooding. An initial grade of 2% sloping away from the building for a distance of 2m shall be required on all sides.
- Note that steep slopes may require special consideration for contouring, erosion control, and terracing with retaining walls, subject to the landscaping and geotechnical requirements.
- Private lots that are lower than adjacent roadways, alleys, PUL's or utility ROW's should be avoided where possible.
- To provide basic positive drainage until a lot is developed, the lot(s) shall be rough graded, allowing for earth balancing of future basement excavation and landscaping. Rough grading is to be within +/- 50 mm and may allow for a lot-by-lot balancing of fill from basement excavations.
- All lots where the lot grading plan has been designed to allow for walk out basements shall be indicated on the overall drainage plan for the subdivision. Deviations from the approved plan will not be considered.
- Retaining walls and drainage easements shall be registered on title by the Owner as part of the Subdivision Plan.

4.14.2.2 Lot Grading, Swales, and Driveways

Lot grading shall be carried out in accordance with Section 4.14.2.1, the BC Building Code, and

the following:

- To ensure flooding is avoided, carports or garages attached to residential buildings shall not be constructed with their floor level below the adjacent curb of the street or crown of pavement of the street, unless:
 - the drainage of the driveway serving the carport or garage is connected by gravity to the Village storm sewer meeting the connection criteria, or
 - is above the 1:200-year HGL, or
 - the runoff water from the driveway may flow past the carport/garage without accumulating and entering.

Properties utilizing this method must have an Engineer seal the design. All other relevant criteria of this document must also be met.

Lot grading swales shall be used to protect adjacent downstream properties from overland sheet flow from uphill lands. Where a lot grading swale conveys drainage across a property line at a point discharge location, a registered easement is required.

Lot grading swales shall meet the following criteria:

- minimum depth = 150 mm
- minimum width = 1.5 metres
- minimum slope = 1.0%
- maximum length = 45m or the width of 3 fee simple parcels unless otherwise approved by the Village
- maximum velocity = 1 m/s
- lined with turf on minimum 300 mm absorbent soil as per Section 3.6.31 or clear crushed rock up to the high-water mark, erosion blanket or approved alternative where velocities exceed 0.6 m/s at the discretion of the Engineer

All such swales serving two or more parcels of property shall be designed to accommodate the anticipated flows and the easement shall be sized accordingly (3.0 m minimum).

4.14.2.3 Habitable Area - Minimum Building Elevation (MBE)

The MBE applies to the elevation of the lowest floor slab in a building or any space or room, including a manufactured home, that is or can be used for dwelling purposes, business, or the storage of goods which are susceptible to damage by floodwater; and for certainty, habitable area includes any enclosed space within a building with headroom greater than 1.5 metres. Crawl space is defined as the space between a floor and the underlying ground having a maximum height of 1.5m to the underside of the joists and not used for the storage of goods or equipment damageable by floodwaters.

The MBE shall be higher than the Flood Construction Level (FCL) as specified in the Section 6(a) of FVRD Bylaw No. 0681. The specified FCL for Harrison Lake is 14.55 metres using the Canadian Geodetic Vertical Datum of 1928 (CGVD28). Careful use of other vertical datum (i.e. CGVD2013, NAD83(CSRs) / CGG2013, etc.) is necessary; elevations will need to be converted carefully. The project vertical datum and converted **FCL shall be shown on the SWMP**. Additionally, the MBE shall be higher than the centreline of abutting roadway if designed to convey the Major Flow on the surface.

MBE's shall not be adjusted or revised without approval of the Village.

Note: this may not apply to replacement of structures/developments within existing flood plains or sites that meet the General Exemptions in FVRD Bylaw No. 0681. In these areas, for which a floodplain elevation has been established, the MBE is 0.30 above the 1:200-year instantaneous flood elevation. Other suitable precautions such as mounting electrical panels above the 1:200-year level shall be taken.

4.14.2.4 Roof Leaders

Roof drainage leaders are to be connected to the storm service connection only where geotechnical requirements dictate the need. The evaluation of this requirement is to be included in the scope of the Hydrogeotechnical Study. Otherwise, roof leaders are to be directed to a splash pad for dispersal to the ground. Roof leaders shall not be directed

onto driveways which drain directly onto Village right-of-way or areas draining directly onto neighboring properties.

Roof drainage from single family and duplexes shall be discharged to the ground and dispersed via splash pads at the downspouts. The point of discharge shall be a minimum 1.5m away from the building (including downspout extensions) to ensure water flows away from it. Provisions shall be made to prevent soil erosion.

Roof drainage from apartment buildings and commercial/industrial areas shall subscribe to the principles of Low Impact Development described in Section 4.7.2 and may only discharge directly to the storm sewer upon approval by the Village.

The Village will only approve discharge of roof leaders to the storm sewer when conditions warrant in order to prevent erosion and/or property damage, and no other cost-effective solution is available.

4.14.2.5 Foundation Perimeter Drains

Perimeter drains for buildings are required as per the British Columbia Building Code.

Foundation perimeter drains shall be connected by gravity via a storm service to the storm main provided that the elevation of the basement/crawlspace floor is at least 600 mm above the elevation of the storm main obvert, 600 mm above the anticipated or known high ground water table, or 600 mm above the 100-year hydraulic grade line within the main at that point, whichever is higher.

When the above provisions regarding the elevation of the storm main obvert or 100-year HGL for gravity connection of foundation perimeter drains cannot be met, a backflow prevention device and sump pump system inside the building discharging to the storm main via a storm service shall be installed. A backwater or check valve and a siphon break must be installed in the sump pump discharge line to prevent backflow into the basement. Discharge may be to the surface or a soak away pit, if geotechnical conditions permit.

Where Hydrogeotechnical studies justify their use, dry wells or ground infiltration systems may be used as the storm water disposal method for connection of perimeter drains. These systems are to be designed and supervised by a Geotechnical Engineer.

4.14.3 Streets, Gutters and Ditches

4.14.3.1 Urban Cross-Sections

Unless Trap Lows conforming to Section 4.14.3.3 are being used, the flooding depths for a 1:10 year storm, which will be permitted on streets, while the streets are acting as part of the minor drainage system, are as follows:

- Storm water must be contained within the road way
- On local roads, maximum depth of ponding will be 150 mm . The flow may spread to the crown.
- On collector roads, the flow spread must leave one lane free of water for emergency vehicles

- On arterial roads, the flow spread must leave one lane in each direction free of water
- Flow across urban road intersections shall not be permitted for storms with a return frequency of 5-years or less

4.14.3.2 Rural Cross-Sections

Rural roads, gravel or paved, shall be constructed with swales or ditches that ensure adequate road subgrade drainage (in compliance with standard road design). Where ditching for minor drainage is provided, ditch design shall consider the following:

- Rip-rap as necessary to eliminate incising and erosion
- Freeboard of 0.3 m
- Free surface elevations permitting agricultural tile drainage where required
- Stable side slopes

4.14.3.3 Trap Lows

Trap lows can be used to manage stormwater on public road rights-of-ways, and on private and public lots within parking areas and other flat-graded areas.

The use of trap lows must conform to the following requirements:

- The maximum depth of ponding shall be 350 mm and the minimum freeboard to the nearest building entrance threshold shall be 300 mm
- Where trapped low areas are included into the design of a storm water minor drainage system, the Owner, at its sole cost and expense and to the satisfaction of the Village, shall register a Stormwater Impoundment Easement and Restrictive Covenant against all impacted properties.
- prohibiting either:
 - any grading or re-grading of the lot, except in strict accordance with the building grade plan as approved by the Village
 - the construction of any opening in the walls of any structures within any lot adjacent to the trapped low areas unless such openings are higher than 0.30 metres above the maximum elevation of the said trapped low areas
- At any trapped low points in roadways, double side inlet CB's are required

4.14.3.4 Ditches

Open ditches for drainage are not acceptable for permanent servicing of Village land unless otherwise approved by the Village.

If confirmed by Geotechnical recommendation, ditches approved adjacent to roadways shall conform to the following:

- maximum depth = 1.5 metres
- minimum bottom width = 0.5 metres
- maximum side slopes = 1.5H:1V
- minimum grade = 0.5%

- flow velocities in excess of 0.6 m/s shall include design details to prevent scouring, erosion and under-cutting
- The minimum statutory right-of-way width for an existing or proposed ditch crossing private property shall be six metres wider than the top width of the ditch
- The ditch shall be offset in the statutory right-of-way to permit access for maintenance vehicles
- The top of a ditch adjacent to a property line shall be a minimum 0.5 metres away from that property line

4.14.4 French Drains (Ground Water Recharge Trench)

French drains shall be provided where the presence of ground water may affect the stability of the existing or proposed road structure. French drains are required where indicated by investigation and soils report(s) prepared by a qualified Geotechnical Engineer and at the discretion of the Village.

Depth of Drain Rock in Ground Water Recharge Trenches shall conform to the following criteria shown on Table 4-4:

Table 4-4 – Depth of Drain Rock in Trenches

Percolation Rate	Depth of Drain Rock Under Perforated Pipe
0-15 min. per 25 mm	200 mm
15-30 min. per 25 mm	300 mm
More than 30 min. per 25 mm	Perforated Pipe not Recommended

4.14.5 Swales

Details regarding lot grading swales are provided in Section 4.14.2.2. Swales can be used in other cases, but must satisfy the same design criteria. Swales may also be used:

- in conjunction with lot grading to provide rear, front and side yard drainage as required or directed by the Village
- to convey overland Major Flows at the discretion of the Village
- on a rural Highway for road drainage at the discretion of the Village

4.14.6 Rock Pits/Dry Wells

Rock pits/dry wells shall be used for single-family infill lot development or replacement or reconstruction of existing homes unless otherwise recommended by a Geotechnical Engineer. The rock pit/dry well shall be designed by a registered Engineer or Hydrogeologist with related experience and sized to store and infiltrate a 1:10 year rainfall event. **Designers should seek Village approval prior or during preliminary design when considering the use of any infiltration facilities.**

The Number of Drywells shall conform to the following criteria shown on Table 4-5:

Table 4-5- Number of Rock Pits/Dry Wells

Percolation Rate	Number of Rock pits / Dry Wells
0-15 min. per 25 mm	5 per Hectare
15-30 min. per 25 mm	10 per Hectare
More than 30 min. per 25 mm	Rock Pits/Dry Wells not Recommended

4.15 Storm Mains

4.15.1 Capacity

Hydraulic capacity for pipes and channels shall be calculated using Manning's formula:

$$Q = \frac{AR^{0.667}S^{0.5}}{N}$$

Where:

- Q = flow capacity (m³/s)
- A = cross-sectional area (m²)
- R = hydraulic radius (m)
- S = slope of Hydraulic Grade Line (m/m)
- N = see Table 4-6 below

Table 4-6 - Common Coefficient of Roughness Values

Pipe Material or Channel Surface	Coefficient of Roughness Value
PVC or other smooth walled plastic pipe	0.011
Smooth walled concrete pipe	0.013
Corrugated steel pipe (unpaved)	0.024
Corrugated steel pipe (invert paved)	0.020
Gravel lined channels	0.020
Concrete or asphalt lined channels	0.013
Natural streams and grassed channels	0.050

4.15.2 Velocity

Minimum = 0.6 m/sec flowing half full or full

Maximum = there is no maximum velocity. However, if the design velocity exceeds three (3) m/s and super-critical flow occurs, provisions for structural stability of the main and durability of the pipe shall be addressed by the Consulting Engineer.

Despite the above, where the slope of the proposed main exceeds 15%, scouring protection and anchor blocking shall be incorporated. A Geotechnical Engineer may be required to provide design details, monitor construction and provide construction reports at the discretion of the Village.

4.15.3 Minimum Diameter

4.15.3.1 Mains

Minimum Diameter: 250mm

4.15.3.2 Services

Minimum Diameter for Residential Services: 100mm

Minimum Diameter for Commercial, Industrial, and Institutional Services: 150mm

4.15.4 Location, Alignment and Grade

Storm mains to be located within roadways, preferably along the centreline, as shown in the applicable standard road cross-section drawings. Manhole covers to be located outside of wheel path.

For curved roads and alignments, where approved by the Village, pipe alignment to be at a parallel offset with an established road right-of-way or property line. Horizontal and vertical alignments should be straight lines between manholes for gravity sewers, and between defined deflection points for force mains.

Servicing from roadways is required. Rear yard sewers are to be avoided, and advance approval is required from the Village.

Where a sewer crosses private land, right-of-way requirements are as indicated in Section 1.1.3. When the storm main is required to cross private land(s), the width must be suitable to accommodate excavations based on WCB regulations for side slopes.

When a storm main is located within a statutory right-of-way and appurtenances which require maintenance are located within the right-of-way, the Owner must ensure that maintenance access is available. For large structures or structures requiring an enhanced maintenance level such as oil/sediment chambers, control structures and pond inlet/outlet chambers, an access route adequate to support the maintenance vehicles is to be provided. The surface of the route may be gravel, pavers or asphalt depending on the location and the context of the site.

4.15.4.1 Minimum Grades

The minimum pipe grades are as per Table 4-7; steeper grades are desirable:

Table 4-7 – Minimum Storm Pipe Grades

Pipe Size (mm)	Minimum Grade (%)
100/150	1.0
200	0.40
250	0.30
300	0.23
375	0.17
450	0.13
525	0.11
600 and larger	0.10

4.15.4.2 Downsizing of Storm Sewers

Downsizing of storm sewers on steeper grades is not permitted for mains 600 mm diameter or less. Downsizing of a maximum of two nominal pipe sizes for mains larger than 600 mm diameter may be considered at the discretion of the Village.

4.15.4.3 Depth of Cover to Obvert

Provide 1.0 m in travelled areas and 0.9 m otherwise for pipes and culverts with a maximum 600 mm diameter, subject to the correct pipe loading criteria. For pipe sizes larger than 600 mm, an engineering design for cover will be required. However, these minimums are to be used only when conflicts with other utilities will not occur and all upstream catchment areas are serviceable by gravity. Where minimum cover is not attainable, a design for concrete encasement should be discussed with the Village.

For Catch basin leads 0.9 m minimum cover shall be used. If 0.9 m is not available, design to protect from freezing and traffic loads, design calculations must be provided.

The elevation of storm sewers at the upstream tributary points must be of sufficient depth to service all of the tributary lands.

4.15.4.4 Curvilinear Mains

If horizontal or vertical curves are used to maintain a constant offset, the radius of the curve is to be no less than 1.5 times the recommended manufacturer's minimum radius of curvature. The design velocity must exceed 0.91 m/sec. and the curve midpoint and

two quarter points are to be located by survey and shown on the as-constructed drawings with an elevation and offset of the invert at each point.

4.15.5 Manholes

Storm manhole spacing is to be related to pipe main size as follows:

- 250 and 300 mm diameter - 135 m maximum spacing;
- over 300 mm to 600 mm diameter - 120 m maximum spacing, and
- over 600 mm diameter - 100 m maximum spacing.

Manholes are required at:

- all grade or alignment changes (except curved sections)
- pipe size changes
- all intersecting mains
- all upstream ends of mains
- upstream and downstream end of all curvilinear mains unless a constant offset is maintained from the curb
- all catch basin connections
- outfalls to the major system (i.e. creeks, channels, lake) in order to isolate the upstream main to facilitate cleaning. The manhole is to be located as close as possible to the point of discharge.

Manhole sizing shall relate to incoming pipe diameters as follows:

Table 4-8 – Storm Manhole Sizing

Inside Pipe Diameter (mm)	Inside Manhole Diameter (mm)
<450	1,050
525 to 600	1,200
675 to 750	1,350
900	1,500
1,050 to 1,200	1,800
>1,200	Riser Manhole

Table 4-8 Notes:

1. All barrel joints shall be made watertight with gaskets or mastic.

4.15.5.1 General Manhole Requirements

Manholes should conform to the following:

- To ensure manhole construction will not cause a loss in hydraulic capacity, the design gradient shall be continuous through the manhole
- Placement of manholes in existing or future wheel paths is to be avoided
- Generally, the crown of the downstream pipe shall not be higher than the crown of the upstream pipe. However, the 0.8 depth point of both pipes may be placed at the same elevation
- A smooth transition shall be provided between the inverts of incoming sewers and the outlet sewer
- Extreme changes in elevation at manholes should be avoided wherever feasible
- Minimum drop in invert levels across manholes to account for energy loss
 - straight run –gradient to be continuous through manhole
 - deflections up to 45-degrees - 20mm drop minimum
 - deflection 45-degrees to 90-degrees - 30mm drop minimum
 - Deflections greater than 90-degrees shall be accommodated using two or more manholes.
- Where drops greater than 0.6 m cannot be avoided, a specifically designed drop manhole will be required to address the hydraulic requirements of the change in elevation. Considerations include:
 - Upstream flow shall be sub-critical, and the pipe shall be of sufficient size so that it does not surcharge
 - A smooth vertical curve shall be formed between the inlet pipe and the drop shaft with no breaks in grade, projections or edges
 - The drop shaft diameter shall be equal to or greater in size than that of the largest inlet pipe. For multiple connections, a larger drop shaft shall be supplied
 - Air vents shall be provided
 - Cover shall be able to withstand pressures from air discharge and surcharging
 - The outlet shall provide a hydraulic jump basin to dissipate energy, to convert the flow to sub critical velocity and to allow for the release of air
- For manhole abandonment, plug all pipes with non-shrink grout, remove and dispose of manhole to 1m below ground and fill with fillcrete
- Storm drain manholes require a 600 mm deep sump unless approved otherwise by the Village.
- No Catch Basin manholes shall be used

4.15.5.2 Manhole Requirement for Services

Connecting storm services to mains shall require manholes based on the diameter of the main and the diameter of the service being connected as per Table 4-9:

Table 4-9 Manhole Requirements for Drainage Service Connections

Diameter of Main	Diameter of Service		
	No Manhole Required	Manhole Required	Not Permitted
150	<150	150	150<
200	<150	150-200	200<
250	<150	150-250	250<
300	<200	200-300	300<
375	<200	200-375	375<
450	<200	200-450	450<
525	<200	200-525	525<
600	<200	200-600	600<
675	<200	200-600	600<
750	<200	200-600	600<
840	<200	200-600	600<
900	<200	200-600	600<
1060	<200	200-600	600<
1200	<200	200-600	600<
1370	<200	200-600	600<

4.15.6 Catch Basins

To ensure that the capture or inlet capacity matches the storm main capacity, the spacing of catch basins on streets may be varied; however, catch basin spacing shall generally meet the following criteria:

- Catch basin spacing shall be designed to drain a maximum area of 500 m² on road grades up to 3%. Road grades greater than 3%, side entry catch basin grates are to be installed.
- Space at intersection so as not to interfere with cross walks

Catch basin leads shall be a minimum of 150 mm in diameter for single C.B.'s and 200 mm for double C.B.'s. All C.B. leads must discharge into manholes. Catch basins shall generally be located as follows:

- At regular intervals along roadways
- At intersections and curb returns wherever practical
- Should be drained into CB's on the upstream side of curb returns and wheelchair letdowns
- At any trapped low points where, double side inlet CB's are required
- At end of curb points unless a hard-surface flow path to a ditch is provided

The Capacity of a single catch basin can be calculated using the orifice formula:

$$Q = kCA\sqrt{2gh}$$

Where:

- k = clogging factor (0.6)
- C = orifice coefficient (0.8)
- A = open area
- g = gravitational acceleration (9.81 m/s²)
- h = depth of ponding (m)

All catch basins shall be complete with trapping hoods. Double catch basins are required at trapped lows and where a single catch basin provides insufficient capacity.

4.15.7 Storm Services

Minimum sizes and grades for storm sewer services shall be in accordance with section 4.15.3 and 4.15.4, respectively.

Storm services to properties shall not be permitted from storm drains located in rights-of-way unless a clean-out is provided complete with Brooks Box, and the nature of the development will permit access to the right-of-way for inspection, maintenance and repair, as necessary. Storm services shall use wye fitting for connections to new mains. For connections to existing main use wye saddles or, if approved, insertable tees.

Storm Service connections into manholes shall be permitted if the following conditions are met:

- The connection is not oriented against the flow in the main
- The manhole hydraulic requirements are met as detailed in Section 4.15.5

4.16 Flood Management - Major System Design (Detention)

4.16.1 Service Level

An urbanized area will have three separate and distinct drainage systems, whether these systems are planned and designed or not. Storm runoff generated by less frequent, higher intensity rainstorms may exceed the capacity of the retention and minor systems. Runoff from these events will pond in depressions and follow whatever overflow route is available. This network of ponding and overland flows is called the "major system". If the major system is properly planned, it can alleviate the potential inconvenience and property damage caused by large rainfall events.

The Major System shall be designed to protect the public and prevent significant property damage due to flooding caused by the rainfall events with a return period of up to 1 in 100 years. The runoff from a 1 in 100-year rainfall event is referred to as the "Major Flow". The Major System shall have the capacity to carry post-development flows not carried by the Minor System or retained/detained in a flow control facility.

Developments are required to provide storage up to the 100-year (plus 10% volumetric safety factor) event with a maximum outlet rate based upon the 10-year pre-development rate generated by the catchment area. The release rate is to be based upon the post-development outlet hydrograph mirroring the pre-development runoff hydrograph up to the 10-year level. Release rates not based on these criteria may be allowed by the Village based on downstream conveyance system protection, stream protection, flood protection or water quality.

Surcharging at an inlet under major flow is acceptable provided that the headwater profile does not rise above the MBE of adjacent properties. The maximum elevation of standing water above existing finished ground surfaces, parking lots, street surfaces etc. caused by any surcharging shall not be greater than 350 mm and the minimum freeboard to the nearest building entrance threshold shall be 300 mm. Adequate erosion protection shall be required where surcharging is evident.

Where surface flood paths cannot be established, pipes and culverts of the existing or proposed Minor System may be enlarged to accommodate the major flow or the major flow can be reduced by detaining it in a storage facility. Emergency overflow routes may be required by the Village.

Large Storage facilities are to include provisions for discharges at rates greater than the design release rate. Rapid drawdown of the water level may be necessary for emergency purposes or to restore the available storage to accommodate subsequent storm events.

Provisions to accommodate higher discharges will involve oversizing the fixed openings and sewers connected to the control structure. Adjustable mechanisms such as slide gates or removable orifice plates can be used to regulate design release rates. The extent of the oversizing will depend on the capacity of the downstream drainage system.

4.16.2 Major System Components

The major system includes all drainage infrastructure which convey, detain, divert and intercept the 100-year design storm runoff. In general, all components of the major system must be designed to accommodate the flows generated by the upstream contributing area. The following section describes the major system provisions and technical requirements for use in planning and design of the major drainage system.

The major system comprises surface flood paths, swales, channels, watercourses, roadways, walkways, pathways, flow control facilities or other Village owned facilities at the discretion of the Village, designed to accommodate the Major Flow. Overland flow paths on Roadways, in swales and watercourses shall be designed to ensure that the maximum hydraulic grade line is below the lowest existing or proposed MBE of adjacent buildings.

To meet the criteria for major storm runoff, sags or low points in roads or subdivisions must be designed with a safe overland outlet flow route.

4.16.2.1 Major Flow Path Swales

Major flow path swales shall be:

- designed for the capacity of the expected flows
- designed with scour protection and energy dissipation
- secured and protected by a statutory right-of-way
- designed with suitable access for continuous maintenance and inspection by the Village.

4.16.2.2 Outfalls

Ministry of Environment approval is required on all storm water outfalls to natural watercourses or waterbodies.

Outfalls into lakes are to be constructed to have minimum bury according to the following:

- soft bottom, 0.6 meters to allow for seasonal sand erosion and deposition
- rock bottom, criteria to be confirmed by Coast Guard
- exposed pipes must be a minimum of 2.4 meters deep during lake "low water" to allow safe passage of deep keel vessels

Lake outfalls require approval from the Canadian Coast Guard.

4.16.2.3 Control Structures

Control structures shall be used to provide consistent control for design storm flows of different return periods. These can be modified to include multi-stage inlets.

Considerations shall be given for the design of smaller sediment trap basins at the points of discharge to the detention/retention facilities. Normally, basin inlets shall be designed to provide sediment containment. Buildup of sediment shall not restrict inflows and suitable designs shall be provided to allow ease of sediment removals.

4.16.2.4 Culvert and Bridge Capacity

The following service levels shown on Table 4-10 are to be used for design:

Table 4-10 - Design Flood Frequency

Road Class	Bridges, Culverts
Arterial and Collector	1:200-year flood
Local	1:100-year storm plus provision for overflow if on a major channel

All culverts (or pipes with inlets or outlets), unless specified in Table 4-11 below, shall be constructed with headwalls and end walls. The headwalls and end walls shall be constructed with a free swinging, weighted grating. To protect against unauthorized entry, a locking mechanism which limits the range of movement of the grating is required.

Table 4-11 - Pipe and Culvert Table

Pipe Length	Pipe Diameter	Headwall	Endwall ²	Grillage	Reinforced Concrete Collar ¹
<20m	=<450mm				1
<20m	>450mm	1	1	Inlet	
>20m	<450mm	1	1	Inlet	
>20m	=>450mm	1	1	Inlet & Outlet	
Any	=>450mm with intersections	1	1	Inlet & Outlet	

Table 4-11 Notes:

1. End walls and collars, as per, MMCD S14 & S15.

Culverts (or pipes) discharging perpendicular to a watercourse may use alternative methods to protect the end of pipe provided they are approved by the Village.

4.16.2.5 Roadway Flood Routes

Major flood routes must be provided on down slope cul-de-sacs. Overflow routes are required at all sags and low points in roadways and other surface flow routes. Flow capacity of road surfaces shall be calculated using the Manning's Formula, which is presented in Section 4.15.1. For roadways and road right-of-way, typical values of the Manning Roughness Coefficient "n" are:

- 0.018 for paved roadway
- 0.03 for grassed boulevard and swales

- 0.04 to 0.10 for irregular or treed channels

For additional Manning Roughness Coefficients, see Section 4.15.1.

4.16.2.6 Ground Recharge Systems

Ground recharge systems shall not be considered for major flood routing.

4.16.2.7 Ditch and Swale Construction

Velocity of flow in ditches and/or swales is not to exceed the limits given in Table 4-12 below for the various types of materials used as the conveyance surface.

Table 4-12 - Maximum Permissible Velocity of Flow

<u>Lining Materials</u>	<u>Maximum Permissible Velocity m/s</u>
Fine sand	0.45
Fine gravel	0.75
Stiff clay	1.00

For velocities higher than the above maximums, the "Rip Rap Design and Construction Guide" as published by the Ministry of Environment of BC, Public Safety Section of the Water Management Branch shall be used.

4.16.2.8 Piped Systems

In special circumstances, or to accommodate lower building elevations, the minor drainage system may be enlarged or supplemented to accommodate major flows. System details should be indicated in the Storm Water Management Plan. Design considerations include:

- Provision of adequate inlets to accommodate major flows
- The requirement for surface overflow routes at potential surface ponding locations
- Design in accordance with minor drainage system guidelines

4.16.3 Stormwater Storage

This section identifies the general design parameters and requirements that must be considered by development proponents in the planning and design of stormwater storage facilities.

4.16.3.1 Peak Flow Control

Control (Detention) on peak flow rates and volumes in the Village are necessary:

- To minimize impacts on watercourses and downstream developments from flow increases which will result from land development

- To maintain or lessen flows in watercourses so that creek channels and existing structures, such as bridges and culverts will continue to operate without being flooded or damaged

In consideration of the above, the Village has the following objectives and requirements:

- Impact and expenditures to existing downstream users shall not be increased
- Increases in peak storm flows and volumes to the watercourses and receiving waters shall be limited
- The number of storage facilities shall be minimized. (Permanent detention will not be permitted under private ownership)
- Permanent storage facilities are to be owned and maintained by the Village
- Where land developments occur in advance of permanent detention facilities, the Village may consider temporary storage facilities on an individual basis. Maintenance charges and responsibility for temporary storage facilities will be borne by the Owner

4.16.3.2 Basis for Detailed Design of Stormwater Storage Facilities

An overflow shall be provided to route any excess water to the designated one-hundred-year flood route. Such an overflow can be in the form of a spillway or may be incorporated in the flow control structure through oversizing of downstream pipes, provision of overflow pipes or such other arrangement as the designer may devise.

4.16.3.3 Geotechnical Considerations

Special geotechnical investigations to address issues related to the design of all stormwater management lakes and dry ponds are to be undertaken as part of the planning and design studies and are a prerequisite to the final design of such facilities.

Wherever possible, the stormwater storage facility shall be excavated in natural, stable ground. Should topography dictate that a berm be constructed along one or more sides of the basin, the berm shall be designed by a qualified professional engineer.

4.16.3.4 Staged Construction - Standards for Interim Facilities

When stormwater management storage facilities are to be implemented in stages, the standards applicable to the design and construction of the interim facilities are to be generally in accordance with the standards set out herein for permanent facilities of that type.

4.16.3.5 Land Dedication

Generally, the area of land covered by water when the basin is at the 10-year water level will be dedicated to the Village. This dedication will also apply to all accesses to inlets/outlets, any structures and maintenance access routes to the facility.

Land that is adjacent to a basin which is subject to flooding as per the design standard established, but which is part of a privately-owned developed parcel, will be required to carry rights-of-way, to allow for encroachment of water onto the affected land. The right-

of-way documents shall be prepared by the development proponent, naming the Village as grantee.

A restrictive covenant will be placed on lots abutting the facility to control lot development so as not to compromise design requirements at the High-Water Level (HWL). This is to ensure an adequate freeboard is maintained.

4.16.3.6 Maintenance Access Requirements

An all-weather access for maintenance vehicles must be provided to all facility works. The access surface shall be a minimum of 4.5 m wide.

4.16.3.7 Emergency Overflow Provisions

The feasibility of an emergency overflow spillway is to be evaluated for each storage facility design and, where feasible, such provisions are to be incorporated in the facility design. The consultant is to identify the probable frequency of operation of the emergency spillway. Where provision of an emergency spillway or overflow route is found to be unfeasible, the design is to include an analysis of the impact of overtopping of the storage facility and the probable frequency of occurrence of overtopping. The functional requirements of the spillway, and the impact analysis for the absence of one, are to consider the possible consequences of blockage of the system outlet or overloading due to consecutive runoff events, such that the storage capacity of the facility may be partially or completely unavailable at the beginning of a runoff event.

4.16.3.8 Landscaping Requirements

Landscaping plans for areas bounding the facility shall be submitted as part of the Engineering Drawings. Landscaping of all proposed public lands included for purposes of the facility and of all proposed rights-of-way on proposed private property up to the design HWL, is to be part of the lake construction requirement and be dependent on the location and the context of the facility. The requirement for landscaping may be irrigated turf, constructed to the satisfaction of the Operations Department.

4.16.3.9 Sediment Removal Provisions

The facility design shall incorporate the ability for sediment capture and efficient removal for the control of solids which may be washed to the facility.

4.16.3.10 Maintenance and Service Manual

As part of the responsibility for design of a stormwater management storage facility the development proponent shall prepare and provide a maintenance and service manual for the facility.

Two complete copies of the manual are to be provided to the Village prior to the time when the operation responsibility of the facility is transferred to the Village, which will generally be at the time of substantial completion. The manual shall include complete equipment manufacturer's operation, maintenance, service and repair instructions, and complete parts lists for any mechanized or electrical equipment incorporated in the design.

The manual is to include, at a minimum, the following information:

- A copy of the approved Engineering Drawings relating to the Stormwater Storage Facility and appurtenances, updated to "As-Constructed"
- Schematic diagrams of the inlet and outlet arrangements, connections to and arrangement of upstream and downstream systems, including all controls, shutoff valves, bypasses, overflows, and any other operation or control features
- Location plans for all operating devices and controls, access points and routes, planned overflow routes, or likely point of overlapping in the case of exceedance of the design containment volume
- Stage Discharge Curves with clear relationships of the stages relative to surrounding features

4.16.3.11 Signage for Safety

The design for SWM Facilities shall include the installation of signage to warn of anticipated water level fluctuations, with demarcation of maximum water levels to be expected for design conditions. Warning signs will be provided and installed by the development proponent.

4.16.3.12 Engineering Drawing Requirements

The engineering drawings for any SWM Facility are to include the following information, in addition to the physical dimensions:

- Stage-Volume and Stage-Area Curves
- elevations at Normal Water Level (NWL), 5 Year Level and High-Water Level (HWL)
- volumes at NWL, 5-year Level and HWL
- freeboard elevation
- notation indicating the lowest allowable building elevation for lots abutting the lake;
- contributing basin size (ha)
- measurements to locate submerged inlet(s), outlet(s) and sediment traps referenced to identifiable, permanent features which are not submerged at NWL.

4.17 Erosion and Sedimentation Control

4.17.1 Service Level

All proposed projects must provide erosion and sedimentation controls to prevent the displacement of soil and the transport of sediment from the project site resulting from land-disturbing activities. To prevent the displacement of soil and the sediment transport during land-disturbing activities, Erosion and Sedimentation Control (ESC) measures are required and shall be performed as described below. Both temporary and permanent erosion and sedimentation controls shall be implemented.

4.17.2 Erosion and Sedimentation Control

The Land Development Guidelines for the Protection of Aquatic Habitat, Department of Fisheries and Oceans and the BC Ministry of Environment (1992) shall be followed for methods of control.

In general, erosion and sedimentation controls shall address the following:

- **Clearing Limits:** Prior to any site clearing or grading, areas to remain undisturbed during project construction shall be delineated and marked on-site by flagging or other method. At a minimum, clearing limit delineation shall be installed at the edges of all sensitive area buffers.
- **Retain existing vegetation, as much as possible**
- **Cover Measures:** Temporary and permanent cover measures shall be provided when necessary to protect disturbed areas. Temporary cover shall be installed if an area is to remain unworked for more than seven days, unless otherwise determined by the Village. Any area to remain unworked for more than 30-days shall be seeded or sodded, unless the Village determines that winter weather makes vegetation establishment infeasible. Slopes and stockpiles 3H:1V or steeper and with more than 3 meters of vertical relief shall be covered if they are to remain unworked for more than 12 hours.
- **Perimeter Protection:** Perimeter protection to contain sediment from sheet flow shall be provided downslope of all disturbed areas when necessary. Such protection shall be installed prior to upslope grading. Perimeter protection includes the use of vegetated strips, as well as more conventional constructed measures such as silt fences
- **Traffic Area Stabilization:** Unsurfaced entrances, roads, and parking areas used by construction traffic shall be stabilized to minimize erosion and tracking of sediment offsite
- **Sediment Retention:** Surface water collected from disturbed areas of the site shall be routed through a sediment pond or trap prior to release from the site, except areas at the perimeter of the site small enough to be treated solely with perimeter protection. Sediment retention facilities shall be installed prior to grading of any contributing area
- **Surface Water Controls:** Surface water controls shall be installed to intercept and convey all surface water from disturbed areas to a sediment pond or trap and discharge it downslope of any disturbed areas, except areas at the perimeter of the site small enough to be treated solely with perimeter protection. Significant sources of upslope surface water that drain onto disturbed areas shall be intercepted and conveyed to a stabilized discharge point downslope of the disturbed areas

4.17.3 Implementation Requirements

4.17.3.1 Erosion and Sedimentation Control Plan

All proposed projects must submit a plan for providing ESC measures.

4.17.3.2 Construction within Sensitive Areas and Buffers

Any construction that will result in disturbed areas on or within a stream or associated buffer, within a wetland or associated buffer, or within 15 meters of a lake shall be subject to the most recent version of the "Land Development Guidelines" published by the Provincial Ministry of Environment. These provisions include phasing the project whenever possible so that construction in these areas is limited to the dry season.

4.17.3.3 Maintenance

All ESC measures shall be maintained as per the Erosion and Sedimentation Control Plans. The consulting engineer shall be responsible for maintenance and review of ESC and for compliance with all conditions relating to ESC.

4.17.3.4 Final Stabilization

Prior to obtaining total performance, the site shall be stabilized and the structural ESC measures (such as silt fences and sediment traps) shall be removed and drainage facilities cleaned as specified.

DRAFT

5 ROADWAYS

CONTENTS

5	ROADWAYS.....	5-1
5.1	General.....	5-2
5.2	Street Trees.....	5-2
5.3	Roadway Classification.....	5-2
5.4	Vertical Alignment.....	5-8
5.5	Horizontal Alignment.....	5-9
5.6	Curb and Gutter, Sidewalks and Bike Lanes.....	5-9
5.7	Driveways and Parking Areas.....	5-9
5.8	Appurtenances.....	5-10
5.9	Pavement Structure.....	5-10

DRAFT

5.1 General

The road standards have been designed for environmental sensitivity with reduced physical impacts in mind. Generally, the street standards proposed herein have been drawn from the following principles:

The public interest requires safe, livable and attractive streets that contribute to the urban fabric;

Streets should be designed to suit their function.

A hierarchical street network should have a rich variety of types, including bicycle, pedestrian and transit routes; and

Standards should be developed to enhance local streets' contributions to urban design. Issues such as sense of enclosure, landscaping, parking, building setbacks, surface materials, street furniture, signs and street lighting are vital determinants of livability in neighborhoods.

These street standards have largely been designed for application under specific traffic volumes and development densities. Traffic volume determines which general street type (Arterial, Collector, Minor Collector, Local, etc.) is required to service an area and, in most cases, density of fronting development determines which specific street condition ("Condition A", "Condition B", "Condition C", etc.) will be applied. In the case of Collector Streets, whether or not the street acts as a village center "main street" is also a factor. For Arterial Streets, proximity to a village center and local environmental conditions are the determinants of "condition" application.

Development that has direct public street access is defined as "fronting" the street. In other words, only those units that are oriented to the street are considered to "front" on it. This will most often occur in areas of fee-simple single family, mixed-use, or apartment development. Circumstances where strata units "front" onto a public street may also arise; however, strata and bare land strata developments will primarily be serviced by Private Streets. Standards for Public Lanes, Cul-de-sac Streets and Road Emergency Accesses are also included.

5.2 Street Trees

Street trees contribute to the livability of a street. Trees modify the microclimate and foster a sense of comfort and safety for drivers and pedestrians by creating an edge between the sidewalk and the moving traffic. In road areas it is desired that the natural landscape be more prominent. Street trees should be planted in accordance with the designs in Schedule C.

5.3 Roadway Classification

An overall plan is required allocating the location of each street type and its relationship to adjacent land uses proposed.

Table 5-1 - Roadway Classification Part 1 of 3

Street Conditions		Street						
Street Type and Condition (Std Drawing number)	Max. Units Served	Design Speed ¹ (km/h)	Max. Grade (%)	RoW (m)	Street Width ² (m)	Parking	Curb & Gutter	Sidewalk ³
Arterial Streets		>600						
Condition A (median) (SS-H1)	within village centre where environmental conditions permit	60.0 (50.0) ⁴	8.0 (10.0)	23.0	16.0 ⁵	none permitted	barrier curb required	required both sides
Condition B (SS-H2)	within 10-minute walking distance ⁷ of village centre; or, within village centre where environmental conditions do not permit the use of Condition A	60.0 (50.0) ⁴	8.0 (10.0)	17.0 ⁸	10.0 ⁸	none permitted	barrier curb required	required both sides
Condition C (SS-H3)	greater than a 10-minute walking distance ⁷ from village centre.	60.0 (50.0) ⁴	8.0 (10.0)	15.0 ⁸	10.0 ⁸	none permitted	barrier curb required	required one side
Village Collector Streets (main street)		600						
Condition A (SS-H4)	where commercial development fronts street	50.0	10.0	20.0	12.8	required on-street both sides	barrier curb required	required both sides
Condition B (SS-H5)	where no commercial development fronts street	50.0	10.0	20.0	12.8	required on-street both sides	barrier curb required	required both sides
Collector Streets		600						
Condition A (SS-H6)	development ⁹ fronts both sides	50 (40) ⁴	10 (12)	18.2 ⁸	8.6 ⁸	required above curb both sides	rollover curb	required both sides
Condition B (SS-H7)	development ⁹ fronts one side only	50 (40) ⁴	10 (12)	14.9 ⁸	8.6 ⁸	required above curb one side	rollover curb required ¹¹	required one side
Condition C (SS-H8)	no development ⁹ fronts street	50 (40) ⁴	10 (12)	14.0 ⁸	8.6 ⁸	none permitted ¹⁰	rollover curb required ¹¹	required one side

Table 5-1 - Roadway Classification Part 2 of 3

Street Conditions		Street						
Street Type and Condition (Std Drawing number)	Max. Units Served	Design Speed ¹ (km/h)	Max. Grade (%)	RoW (m)	Street Width ² (m)	Parking	Curb & Gutter	Sidewalk ³
Minor Collector Streets		500						
Condition A (SS-H9)	development ⁹ fronts both sides; or, development ⁹ fronts one side only	50 (40) ⁴	10 (12)	13.3 ⁸	7.0 ⁸	required above curb one side	rollover curb required	required one side
Condition B (SS-H10)	no development ⁹ fronts street	50 (40) ⁴	10 (12)	12.4 ⁸	7.0 ⁸	none permitted ¹⁰	rollover curb required	required one side
Village Local Streets		200						
Village Local (SS-H11)	development ⁹ fronts at least on side	40 (30) ⁴	12.0	17.4	8.7	required on- street both sides	barrier curb required	required minimum one side
Local Streets		200						
Condition A (SS-H12)	development ⁹ fronts both sides	30.0	15.0	14.1	6.0	required above curb both sides	rollover curb required	optional one side
Condition B (SS-H13)	development ⁹ fronts one side only	30.0	15.0	12.3	6.0	required above curb one side	rollover curb required	optional one side
Condition C (SS-1114)	no development ⁹ fronts street	30.0	15.0	10.5	6.0	none permitted ¹⁰	rollover curb required	optional one side

Table 5-1 - Roadway Classification Part 3 of 3

Street Conditions		Street							
Street Type and Condition (Std Drawing number)		Max. Units Served	Design Speed ¹ (km/h)	Max. Grade (%)	RoW (m)	Street Width ² (m)	Parking	Curb & Gutter	Sidewalk ³
Public Lane		10							
(SS-H15)	all cases		20	12 (15)	6.0	5.7	on edge of paved surface	rollover curb required	none
Emergency and Utility Vehicle Access		--							
provide a secondary access route, if possible, where a cul-de-sac exceeds maximum street length as specified by the Village			--	15.0	4.5	4.5	--	--	--

Table 5-1 Notes:

1. See Table 2 for alignment design criteria for each design speed.
2. Street width measured from curb face (gutterline).
3. For all conditions, sidewalks should terminate at a destination or connect with another sidewalk or trailhead.
4. Minimum permitted design speed reduction, where necessary due to topographic constraints, and approved by the Village.
5. Separate left turn lanes to be provided in the medians.
6. Where no fronting development (driveway access not required), barrier curbs to be considered to restrict illegal parking on sidewalks.
7. For this purpose, the 10-minute walking distance is considered to be 1/2 mile (0.8 km).
8. Where required, ROW and street widths will be increased at major intersections to provide for separate turning lanes.
9. "Development" includes all residential, mixed-use, commercial, institutional and park uses.
10. All parking shall be managed on-site or within small parking pullouts, as required.

5.3.1 Arterial Streets

Arterial streets provide a continuous drive path for inter-community through traffic. The Arterial corridors of road areas will be different in that, while they will continue to provide a throughway for automobiles, the experience will take on qualities of a scenic drive.

5.3.2 Village Collector Streets ("Main Street")

Collector streets perform the dual function of land access and traffic movement between arterial and local roads. In the village center is the unique and very social function of this more localized type of street will be reflected in a more urban feel than will be found on collectors elsewhere throughout the Village.

5.3.3 Collector Streets

Collector streets perform the dual function of land access and traffic movement between arterial and local roads; however, this more localized type of street plays a social as well as a functional role in the neighbourhood. Street design, therefore, must balance all objectives including, but not limited to, the need to provide a driving path for automobiles to access the neighborhood.

5.3.4 Minor Collector Streets

There is the potential for some portions of Collector streets to experience lower traffic volumes. In these instances, Minor Collector streets will be utilized. Toward reducing the street section, a sidewalk will be provided on only one side of the street for all Minor Collectors.

5.3.5 Village Local Streets

The residential areas of the village center will be more urban than those that will be found elsewhere within the Road areas. Narrow local streets with on-street parking and framed by street trees and sidewalks on both sides will provide a comfortable environment for all users in the neighbourhood. This condition is for use where development fronts at least one side of the street.

5.3.6 Local Streets

Local streets serve a multitude of functions that are important in the day-to-day lives of residents: residents walk their dogs on the street, they wash their cars on the street, and they meet and talk to their neighbours on the street. Children play on the street; they learn to ride their bicycles on the street; they treat the street as an extension of the local neighbourhood park system. At this level, the street plays a very social role. Local street design, therefore, should continue to be sensitive to the needs of non-vehicle street users as well as seeking the best fit between street and landscape.

5.3.7 Public Lanes

Public Lanes are also used by the residents of a community as a venue for social interaction and play and they can contribute greatly to the fabric of a livable community. One opportunity for their use, however, is in areas such as the village center. Such higher

density development is generally located in more gently sloping areas. The inclusion of Public Lanes in these neighbourhoods will contribute to the more urban feel envisioned as well as provide an alternate route for bikes and pedestrians.

5.3.8 Cul-de-Sac Streets Road Emergency Accesses and Road Private Lanes

Generally, cul-de-sac streets are used where street connectivity is not possible or not warranted (i.e. serves very few homes). Although the appropriate Local street standard will also apply to cul-de-sac streets, there are two additional street specifications unique to this street form that must be addressed in relation to livability: permitted length and the design of the street turn-around.

Longer cul-de-sac streets will result, and systems of branching cul-de-sacs will be established to access some areas. In response to public safety issues, it is desirable that emergency access routes to such areas are available — Road Emergency Access standards are included below. This is considered more acceptable from a livability stance than requiring street connectivity in all situations as the lower standards required for an emergency access will result in a lesser impact to the road. Maintaining street connectivity wherever possible will remain a priority.

The radius of a cul-de-sac also plays a role in the livability of a street. Laying a cul-de-sac requires a relatively large flat area. The larger this area is, the greater the impact to the landscape. Large cul-de-sacs can also decrease the social quality of a street by terminating the public corridor with a large, barren paved surface. A reduction of the cul-de-sac radius is feasible if parking is restricted in the cul-de-sac, which will ensure a large enough circumference for car turning. It is noted that provision must be made on a case-by-case basis for emergency vehicle turning.

5.3.8.1 Cul-de-sac

ROW: min 15.0m radius

Radius to edge of paved surface: min 14.0m radius;

Alternative types of street turnarounds will be considered for use based on site specific topographic conditions. In certain circumstances, hammer head type turn-arounds will be permitted.

A turn-around or a second point of access is required on roads longer than 100 m. Cul-de-sac streets may exceed the maximum length 200 m with the written approval of the Village. Mid-block turnarounds should be considered as a secondary emergency access for any public cul-de-sac streets that are in excess of 200 m.

5.3.8.2 Road Emergency Access

Maximum grade: 15%;

6.0m ROW; 4.5m roadway;

Restrict non-emergency vehicles access through the use of removable bollards or gates;

5.3.8.3 Road Private Lanes/Emergency Access Lanes/Maintenance Roads

Maximum grade: 15%;

Private Lanes must have a turn-around at or near their terminus. Acceptable turn-around types include cul-de-sac or hammerhead with Village approval.

6.0m ROW; 6.0m roadway.

5.4 Vertical Alignment

The vertical alignment of roads must be set so the grades of driveway to adjacent properties will conform to MMCD Drawing C7. Where it is impractical to meet these criteria, the Village may approve the use of private access roads.

The minimum and maximum road centreline grades allowed on various classes of roads must be as per Table 5-2 (Alignment Design Criteria 1-7).

At road intersections, the minor road and/or cul-de-sac must be constructed with an approach grade of not greater than 3% for not less than 15 m from the adjacent edge of asphalt of the major road.

The draining grade around the outside curb of a cul-de-sac must be not less than 0.50% and not greater than 5.00%. Longitudinal gradients of cul-de-sac bulbs shall not exceed 5.00%.

When a cul-de-sac is at the bottom of a hill, the longitudinal gradient of the first 50m of roadway uphill from the cul-de-sac bulb shall not exceed 5.00%. The maximum longitudinal gradient for the rest of the hill shall not exceed 8.00%.

When a cul-de-sac is at the top of a hill, the longitudinal gradient for the roadway downhill from the cul-de-sac must not exceed 12.00%.

All changes in gradient over 1.00% on arterial and collector Roads and over 2.00% on all other road classifications must be connected by vertical curves. Vertical curves must be designed in accordance with the latest edition of the Geometric Design Guide for Canadian Roads as published by the Transportation Association of Canada.

Standard cross slopes (normal crown) must be 2.00% on all road classifications unless approved otherwise by the Village. Design road elevations must give due consideration to flood-proofing requirements of adjacent properties.

Gutter elevations on curb returns and cul-de-sacs must be shown on the drawings at the beginning, one-quarter points and end of curb returns and at 7.5 m intervals around cul-de-sacs.

Table 5-2 – Alignment Design Criteria 1-3

Alignment Design Criteria				
1. Horizontal Curve Radii				
Criteria	60 km/h	50 km/h	40 km/h	30 km/h
Roadway Crossfall				
normal crown (-2%)	260m	165m	90m	25m
2% superelevation	205m	120m	65m	25m
4% superelevation	150m	80m	45m	22m
6% superelevation	120m	-	-	-
Through Intersections	200m	120m	70m	40m
2. Superelevation				
Criteria	60 km/h	50 km/h	40 km/h	30 km/h
Maximum Superelevation	6%	4%	4%	4%
Maximum Superelevation at Intersections	4%	4%	4%	4%
3. Superelevation Transition Lengths				
Criteria	60 km/h	50 km/h	40 km/h	30 km/h
Transition Lengths (2/4-lane road)				
normal crown to +2%	24m / 36m	22m / 34m	20m	20m
normal crown to +4%	38m / 54m	33m / 50m	30m	30m
normal crown to +6%	48m / 72m	-	-	-
Min Tangent Length between				
2% superelevation (2/4-lane road)	15m / 22m	13m / 20m	12m	12m
4% superelevation	28m / 42m	26m / 40m	24m	22m
6% superelevation	42m / 64m	-	-	-

Table 5-2 (Criteria 1-3) Notes:

1. Values for transition lengths include tangent runoff applied at the same rate as superelevation runoff.
2. 60% of superelevation runoff occurs on the tangent approach and 40% on the curve, resulting in a minimum length of tangent between reversing curves of 120% of the superelevation runoff length.

Table 5-2 – Alignment Design Criteria 4

Alignment Design Criteria (cont)				
4. Gradients				
Criteria	60 km/h	50 km/h	40 km/h	30 km/h
Minimum Grade	0.5%	0.5%	0.5%	0.5%
Maximum Grades				
on horizontal tangents	8% ¹	10% ²	12%	12%
on minimum radius horizontal curves ³	8%	9%	10%	10%
Grades Through Intersections				
with design speed on major road	8%	8%	8%	-
approach distance for major road ⁴	15 / 5m ⁵	5m	0m	-
with design speed on minor road	5% ⁶	5%	6%	6%
approach distance for minor road ⁷	20m	15m	5m	5m

Table 5-2 (Criteria 4) Notes:

1. Under special circumstances, grades up to 10% may be permitted
2. Under special circumstances, grades up to 12% may be permitted
3. Applies where radius is less than 1.5 times minimum allowable radius
4. Minimum distance back from the gutter line of the minor road that the specified grade may not be exceeded
5. Distances for design road approach to intersection with collector road / local road
6. 4% desirable
7. Minimum distance back from the gutter line of the major road that the specified grade may not be exceeded

Table 5-3 – Alignment Design Criteria 5

5. Vertical Curve K Values				
Criteria	60 km/h	50 km/h	40 km/h	30 km/h
Minimum Crest	15	8	4	2
Minimum Sag	10	7	4	2
Crest / Sag on approach to stop condition	4	3	2	2
<i>K values listed assume that new roadways will be illuminated</i>				

Table 5-3 – Alignment Design Criteria 6-7

6. Stopping Sight Distances				
Criteria	60 km/h	50 km/h	40 km/h	30 km/h
Down grades: 12%	109	78	52	34
9%	101	73	50	32
6%	94	69	48	31
3%	89	66	46	30
0%	85	63	45	30
Up grades: 3%	81	61	44	29
6%	78	59	42	29
9%	76	57	41	28
12%	73	56	40	28
7. Decision Sight Distance				
Minimum decision sight distance for 60 km/h: 175m — 235m.				
1. Note that decision sight distance applies only to multi-lane roads at intersections.				
2. The range of values recognizes the variation in complexity that occurs at various sites. For less complex situations, values towards the lower end of the range are appropriate and for more complexity, values at the upper end are used.				

5.5 Horizontal Alignment

The horizontal centreline alignment of the road will be located on the centreline of the right-of-way, unless approved otherwise by the Village. Typical locations of works and utilities in Roads are shown on Standard Drawings.

Centerline chainage stations must be fully referenced and dimensioned from property lines.

Minimum radius of curve and maximum super-elevation normally allowed are shown in Table 5-2. The Minimum radius of curb return at intersections must be 7.50 m. Transitions in road widths, tapers, etc., must be formed with smooth curves and tangents, including no less than 30:1 for 50 km/h design speeds and preferably 40:1 taper.

A horizontal curve must be fully described showing internal angle, radius, tangent length and arc.

Curb returns located on roads within industrial and commercial areas may require a larger radius to facilitate truck traffic and bus traffic and will be as specified by the Village.

When a new road with curbs intersects an existing road without curbs, the full curb return must be constructed. Full curb returns must be constructed at the intersection of two curbed roads.

5.6 Curb and Gutter, Sidewalks and Bike Lanes

The standards for curbs, gutters, sidewalks and bike lanes shall be as detailed in Table 5-1 and in the MMCD standard drawings and Village of Harrison supplemental drawings to the MMCD.

Wheelchair ramps must be provided at all intersections as an integral part of the sidewalk.

On roadways with sidewalk and street lighting designed for one side only, the street lighting shall be on the same side as the sidewalk.

5.6.1 Access Points in Sidewalks

Access points (vaults, services boxes, etc.) shall be designed to withstand a loading of H-20 (highways standard).

5.7 Driveways and Parking Areas

Each property shall only have one driveway access per road frontage. Upon demonstrated need and approval from the Village, more than one driveway access may be granted to service stations, major commercial and other developments. Where a lot abuts a lane or road of different classification, the driveway shall be located to access the lane or road of the lower classification.

Residential driveway access onto an arterial or Class 1 collector road, is not permitted unless alternate access is impossible. Wherever physically possible, alternate local road or lane access shall be dedicated to precluding residential driveways accessing directly onto major roads.

Residential driveway accesses serving corner lots shall be a minimum of 7.0 m from the lot corner nearest the intersection. All residential driveway accesses shall have a minimum width of 4.0 m and a maximum width of 6.0 m. The minimum length of a driveway must 6.0 m measured from the face of the building foundation to the nearest front property line.

Driveway accesses to commercial and industrial corner lots shall be a minimum of 15.0 m from the property line of the adjoining road. The maximum width of a driveway to a commercial or industrial property having only one access shall be 11.0 m. The maximum width of each driveway to a commercial or industrial property having more than one access shall be 9.0 m.

At the discretion of the Village, access to large parking areas shall be by curb returns rather than a driveway letdown. The Village may require deceleration and acceleration lanes for access off major roads for safety reasons and to minimize disruption to traffic flows. Design of such access shall follow the recommendations in the Ministry of Transportation & Highways, Highway Engineering Branch "Design Manual".

5.8 Appurtenances

All proposed traffic islands, retaining walls, guard-rails, and permanent barricades must be designed in keeping with good engineering practices.

Traffic control devices shall be designed and installed in accordance with applicable and current Village requirements.

For all utility poles and tie-downs which require re-locating prior to road construction, the utility must confirm the feasibility of their re-location prior to design completion with Village approval.

5.9 Pavement Structure

5.9.1 Subgrade Preparation

Subgrade preparation shall be considered integral for construction of new roads.

Frost Susceptible Soils (ML):

The susceptibility of soils to frost heave is commonly classified using the US Corp of Army Engineers four categories, as shown in Table 15.2 of the "Canadian Foundation Engineering Manual", 3rd edition, 1992. All geotechnical reports shall address the frost susceptibility of the subgrade soil.

Swelling Soils (CH):

Pockets of soils known to change volume with variation of moisture content are known to exist in several locations within the limits of the Village. These soils are typically identified as high plastic clays (CH) using the Unified Soil Classification System and Atterberg Limits index test (ASTM D4318). Where these soils are encountered as subgrade, special subgrade preparation considerations are required, as outlined below.

Scarification should render the subgrade to cohesive pieces of a maximum size of 20 mm to allow adequate moisture conditioning of the soil. The soil should be moisture conditioned to achieve a homogeneous moisture content between 0 and 3% over optimum. Following moisture conditioning, the subgrade soil should be compacted to a minimum of 95% of Modified Proctor density, as determined by ASTM D1557. The subgrade should be covered with granular sub-base as soon as practical to minimize the variation of the moisture content in the subgrade. The contractor should be aware that additional moisture condition and compaction may be required, at the contractor's expense, should the moisture content be allowed to vary significantly from optimum prior to placing the sub-base.

5.9.2 New Pavement Design

Designers of pavement structures shall consider four primary factors in undertaking a specific design.

These are:

1. Subgrade support quality (geotechnical report)
2. Design life (20 years)
3. Traffic loading (expressed in ESALs)
4. Climate.

New pavement structures shall be designed in accordance with the methodologies presented in "AASHTO Guide for Design of Pavement Structures", 1993. The pavement structure shall be designed for a 20-year design life.

The AASHTO design method is based on a Structural Number (SN) for the entire pavement structure (i.e. hot mix asphalt, granular base and granular sub-base). The method incorporates the subgrade strength expressed as the Subgrade Resilient Modulus (M_r), and design loading (ESALs). Each component of the pavement structure is assigned a layer coefficient.

Subgrade strength is frequently characterized utilizing the California Bearing Ratio (CBR) test procedure (ASTM D1883). This test should be performed on soaked subgrade soil specimens compacted to 95% of Modified Proctor density as determined by ASTM D1557. The Resilient Modulus may be approximated from the soaked CBR test values using the following relationships:

M_r (MPa) = 10.3 CBR, or

M_r (psi) = 1,500 CBR

The soaked CBR properties of subgrade soil should be determined at a frequency of at least one test per every 150 lineal meters, or a portion there of, and for each major soil type encountered. Where more than one test is required, the tests should be evenly spaced.

The required SN for the pavement structure is the sum of the product of the layer coefficient, the component thickness, and a drainage coefficient for each component:

$$SN = a.D. + abDbMb + asbpsbMsb$$

Where:

- SN = Structural Number for pavement structure
- a. = layer coefficient for hot mix asphalt (0.4)
- Ab = layer coefficient for granular base (0.14)
- Asb = layer coefficient for granular sub-base
- D. = (0.10) Thickness of hot mix asphalt (mm)
- Db = Thickness of granular base (mm)
- Dsb = Thickness of granular sub-base (mm)
- Mb & Msb = layer drainage coefficient (1.0 for Village)

Road classifications, design traffic values and minimum depths of hot mix asphalt and granular base components of the total pavement structure are defined in Table 5.4.

Table 5-4 - Minimum Asphalt & Granular Base Depth vs Design Traffic

Road Classification	Design Traffic (ESALs) ⁽¹⁾	Minimum Depth of Hot Mix Asphalt	Minimum Depth of Granular Base
Walkways	n/a	50	75
Local, Lanes & Access Roads	2.8 x 10 ⁴ (28,000)	50	75
Collector	2.8 x 10 ⁵ (280,000)	100	75
Arterial ⁽²⁾	1.0 x 10 ⁶ (1,000,000)	100	75

Table 5-4 Notes:

1. See Part 1 Chapter 1 of American Association of State Highway and Transportation Officials (AASHTO) for definition of an Equivalent Single Axle Load (ESAL).
2. Special design reviews may be requested by the Village.

Standard pavement structures, including required SN values, are provided on Table 5-5 for three strengths of subgrade. The standard pavement structures incorporate the minimum depths of hot mix asphalt and granular base shown in Table 5-4.

Table 5-5 - Standard Pavement Structures Part 1 of 2

Street Classification	Structure Component	Thickness in mm for Soaked CBR ⁽¹⁾ of		
		3.0 ⁽⁴⁾ <CBR55	5.0<CBR510	CBR>10
Walkways	Asphalt - Surface Course	50	50	50
	Granular Base	75	75	75
	Granular Sub-base ⁽³⁾	150	150	150
	Required SN Value	n/a	n/a	n/a
Local, Lanes & Access Roads	Asphalt - Surface Course	50	50	50
	Granular Base	75	75	110 ⁽²⁾
	Granular Sub-base ⁽³⁾	275	165	0
	Required SN Value	58	47	35
Collector	Asphalt - Surface Course	40	40	40
	Asphalt - Base Course	60	60	60
	Granular Base	75	75	100 (2)
	Granular Sub-base	335	185 (3)	0
	Required SN Value	84	69	53
Arterial	Asphalt - Surface Course	40	40	40
	Asphalt - Base Course	60	60	60
	Granular Base	75	75	75
	Granular Sub-base	535	355	155 (3)
	Required SN Value	104	86	66

Table 5-5 Notes:

1. Soaked CBR value shall be at 95% of Modified Proctor maximum dry density and optimum moisture content, as determined by ASTM D1557.
2. Placement of equivalent sub-base layer is not practical and shall be replaced with additional granular base.
3. Maximum aggregate size of sub base material to be no more than 50% of total depth of sub-base.

4. Where the top 1 m of subgrade has a soaked CBR value of less than 3, then the subgrade strength should be supplemented with an additional thickness of granular sub-base material in order to achieve a soaked CBR value of 3 or greater. The thickness of the supplemental sub-base and the corresponding composite CBR value for the top 1 m of composite subgrade can be determined by the following formula:

$$\text{CBR Composite} = ((t_{\text{ssb}} \times \text{CBR}_{\text{ssb}}^{0.33} + (1004_{\text{ssb}}) \times \text{CBR}_{\text{sg}}^{0.33}) / 100)^3$$

Where CBR Composite is 3 or greater.:

t_{ssb} = thickness of supplemental sub-base (cm).

CBR_{ssb} = CBR value of supplemental sub-base

CBR_{sg} = CBR value of subgrade soil.

Design pavement structure to be placed on a prepared subgrade or adequately compacted fill embankment. Refer to Section 4.8.1 and 02226 of the MMCD.

Granular base and granular sub-base to have a minimum soaked CBR value of 80 and 20, respectively.

For design purposes, the maximum subgrade soaked CBR value shall not exceed 10.

Required physical properties for granular base and granular sub-base are given in MMCD Schedule 5, Section S02226.

Staged construction may be considered by the Village when a road is to be constructed and to be widened at a later date.

Table 5-5 provides standard pavement structures for roads constructed on only three strengths of subgrade. Alternate pavement structures may be designed based on the SN determined using Figure 1. For example, for a Collector Road with soaked subgrade CBR value of four, then the corresponding pavement structure requires a SN of 75. Using the Structural Number (SN), and the specified layer coefficients, a suitable pavement structure alternative may be determined as shown on Table 5-6:

Table 5-6 - Example Pavement Structure

Pavement Structure Component	Thickness, D (mm)	Layer Coefficient, a	SN
Hot Mix Asphalt	100	0.40	40
Granular Base	100	0.14	14
Granular Sub-base	210	0.10	21
Total SN			75

Note that the minimum depths of hot mix asphalt and granular base shown on Table 5-4, and the required SN have been met.

The curves shown on Figure 5-1 are derived from the methodologies presented in AASHTO. A description of all variables used to derive the curves is presented in the MoT Technical Circular T - 9/95, "Pavement Design Standards".

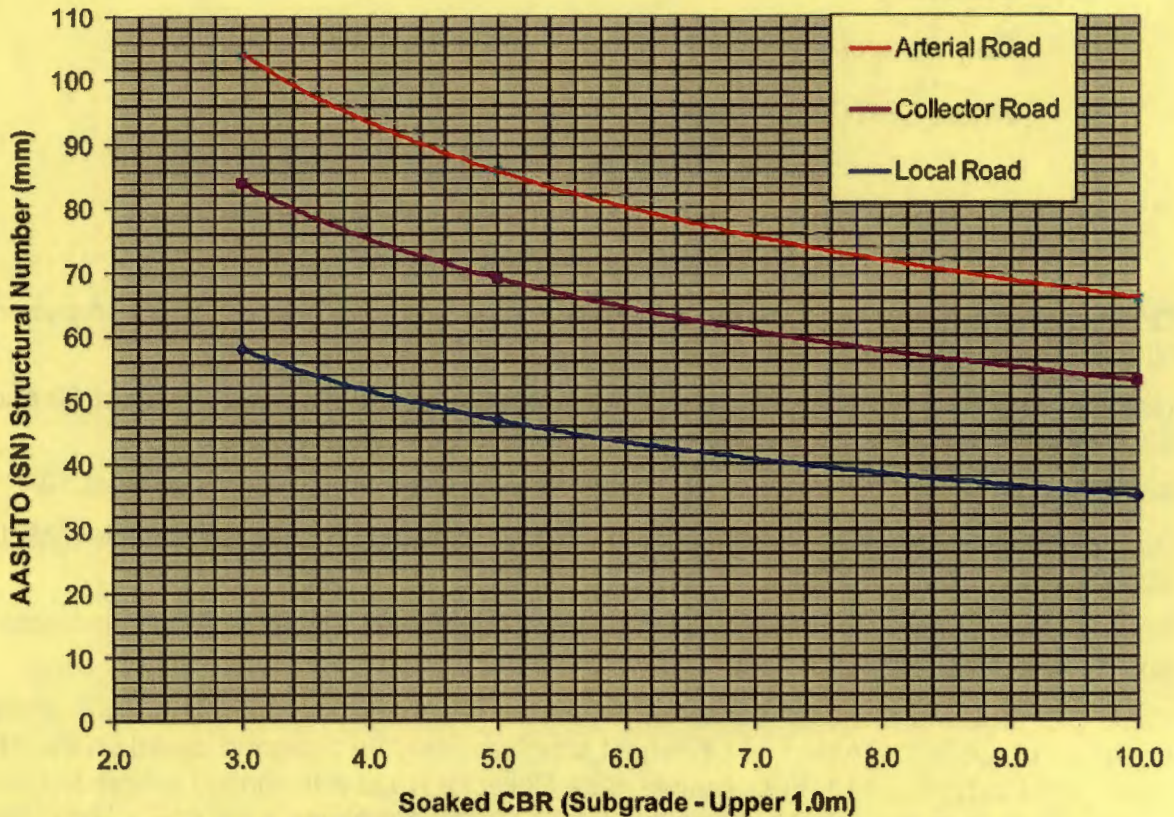

Figure 5-1 - AASHTO Structural Number (SN) Values for Village Street Classifications as a function of Soaked Subgrade CBR Values

5.9.3 Design of Overlays for Existing Pavements

Overlay designs for existing pavements are to be performed in accordance with "Technical Publication No. 12" published by the Roads & Transportation Association of Canada. The design criteria for overlays are based on limiting Benkelman Beam deflections as follows in Table 5-7:

Table 5-7 - Benkelman Beam Criteria for Overlays

Road Classification	Maximum Deflection (mm)
Arterial Roads	1.00
Collector Roads	1.25
All Other Road Classifications	1.50

Table 5-7 Notes:

1. The design Benkelman Beam rebound ($x + 26$) should be determined on the basis of at least 10 uniformly spaced readings per two-lane kilometer (one half in each lane).
2. The summary rebound statistic for a pavement section should be seasonally adjusted to the spring peak rebound value.

DRAFT

6 LANDSCAPE AND IRRIGATION

CONTENTS

6	LANDSCAPE AND IRRIGATION	6-1
6.1	General	6-2
6.2	Boulevard Landscape	6-4
6.3	Median Landscape	6-5
6.4	Utilities Coordination with Planning	6-5
6.5	Plant Material	6-5
6.6	Landscape Maintenance Schedule	6-11
6.7	Irrigation Design	6-11

DRAFT

6.1 General

6.1.1 General Landscape Requirements

The general design and construction of the landscape shall be in accordance with the standards set out in this section.

Street Tree plantings shall be required on streets in all subdivisions where new roads (including cul-de-sacs) or road extensions are required.

Rough grass or wildflower mixture may be used on all or part of boulevards visually backed by areas of woodland or rural appearance - subject to the approval of the Village.

The Landscape Maintenance Period for landscape establishment shall be one year from the date of Substantial Performance of the landscape components of the work. All landscape areas shall be provided establishment maintenance which shall include irrigation maintenance and watering, mowing, weeding, pruning and supplemental fertilization until the end of the Landscape Maintenance Period. The Landscape Maintenance Period shall continue until a Certificate of Acceptance of all Landscape Works and Services is issued by the Village upon the expiration of the Landscape Maintenance Period.

Plants or other materials that fail in the Landscape Maintenance Period shall be replaced at no cost to the Village. Replacement trees shall be guaranteed for a further year after planting, with maintenance and replacements repeated until trees are provided that are acceptable to the Village at the end of the Landscape Maintenance Period.

6.1.2 Landscape Plan Requirements for Works and Services

For landscape Works and Services that will be owned by the Village, the Owner's Qualified Professional is required to submit the following plans, gain Village "Issued for Construction" documents, and certify construction quality assurance. Landscape plan and design submittals required are:

- Landscape Plan
- Landscape Grading Plan
- Irrigation Plan

The following information shall be shown on the Landscape Plan:

- Property lines and easements
- Buildings, edge of pavement, curb lines and curbs, sidewalks, lighting fixture locations, surface utilities and related service boxes or other elements that would affect the landscape and street tree location
- Location of all existing vegetation to remain
- Location of retaining walls and existing or proposed slopes that exceed 3:1 vertical
- Location of all proposed trees, shrubs, ground cover and lawn areas
- Indication of which areas will be seeded grass vs sodded lawn

- Plant list showing botanical name, common name, size at planting, quantity, typical spacing, and root zone volume of supplied growing medium for trees
- Location of all proposed trees, shrubs, ground cover and lawn areas
- Water features, if applicable
- Type of mulch and application depth
- Growing medium depths for each planting type

The following information shall be shown on the Landscape Grading Plan:

- Spot elevations of top and bottom of retaining walls and at top and bottom of any slopes exceeding 3:1
- Drainage patterns by slope arrow and percent slope. Drain inlets or culvert inlet elevations.
- Finished floor elevations if applicable
- General shaping of finished grades by a combination of proposed contour, spot elevations and slope arrows for landscape areas that are bermed, dished, or that have noteworthy grading constraints or design intents
- Stormwater retention or infiltration facilities if applicable
- Rain harvesting or catchment technologies if applicable

The general requirements used by the Village for review of the Landscape and Grading Plan is specific to the site and use thereof. The landscape design shall:

- Respond functionally and aesthetically to existing and proposed land uses, utilities, terrain and flood patterns, drainage facilities, roads, driveways, cycle, transit and pedestrian facilities
- Promote accessibility as it relates to pedestrians, cyclists and people with limited physical or visual abilities
- Consider appearance of the proposed plant material and site landscape, including appropriateness, aesthetics, visual screening, sight lines and functionality
- Provide access for maintenance equipment and personnel
- Allow for cost effective maintenance methods and practices
- Provide access to park, recreation or environmental opportunities
- Incorporate protection of existing trees where feasible. See the Standard Details
- Topsoil and growing medium specification and depths to follow BC Landscape Standards based on proposed application
- Consider protection of the natural environment and restoration or enhancement of natural habitat
- Coordinate with engineering site drainage, water levels, ponding and overland flow
- Consider design features that minimize the opportunity for crime and undesirable behavior
- Provide for weed control

- Coordinate with sediment and erosion control practices
- Follow fire hazard reduction principles

The completed Landscape and Grading Plan(s) shall be considered part of the package that forms the "issued for Construction" documents.

6.1.3 Landscape Construction

Prior to the start of construction; the Owner shall provide the Village with a schedule of construction of the landscape and irrigation Works and Services and Related Work. In addition, the Owner shall provide the Village with the name and contact information for the Consulting Landscape Designer and Engineer, Certified Irrigation Designer, the general Contractor and the Landscape Contractor of the site, as well as the designated Contract Administrator for each of the Landscape and Irrigation works.

Proposed changes to the landscaping from that shown on the "Issued for Construction" Landscape Drawings or related documents shall be submitted to the Village for review and approval at least five working days prior to anticipated construction of the change. Submission of a proposed change in no way implies or suggests approval of the proposed change by the Village.

Changes to the landscaping performed without approval from the Village will not be accepted at the time of Substantial Performance or Total Performance. Changes to the landscaping performed without approval from the Village will be corrected by the Owner at the Owner's expense or the cost of making the corrections will be held back by the Village upon release of the Security Deposit.

6.2 Boulevard Landscape

Unless specified otherwise herein boulevards shall be vegetated with sodded lawn or densely planted groundcover. Rough grass and/or wildflower seeding may be used on boulevards and side slopes that are visually backing onto natural or rural areas, or for temporary boulevard treatments, subject to the approval of the Village.

For boulevards adjacent to commercial property the boulevard treatment shall generally be turf or hard-surfaced and shall include street trees and irrigation. Acceptable hard surface materials for the boulevard may include:

- exposed aggregate concrete
- stamped and colored concrete
- irrigated turf
- xeriscape or dryland landscaping

For boulevards where the land use of the adjacent property is industrial, institutional or multifamily the boulevard treatment shall generally be street trees and turf or dryland landscaping, serviced and maintained by the Owner of the parcel with the boulevard frontage.

For boulevards where the land use of the adjacent property is residential or park, and where the boulevard is accessible for maintenance mowing and watering from the adjacent property, the boulevard treatment shall generally be street trees and turf.

For boulevards where it is unlikely that the adjacent property owner will be able to adequately maintain the boulevard, the boulevard treatment shall generally be hard surfaced and include street trees. Acceptable boulevard materials in these cases may include stamped coloured concrete or exposed aggregate concrete.

6.3 Median Landscape

The landscaping of medians shall be designed and constructed generally as follows:

- with sloped aprons of exposed aggregate concrete or stamped and colored concrete and irrigated street trees

The landscaping of roundabouts and cul-de-sac islands shall have a hard surface material or landscaping with low shrubs or groundcovers, and should feature:

- a single specimen tree
- a group of like trees
- public art

Lighting of trees or public art in a median shall be provided as required.

6.4 Utilities Coordination with Planning

Underground utilities shall be aligned and buried to provide a continuous 1.0m deep utility-free trench beneath tree planting locations.

Planting and paving design shall be co-coordinated with the design and construction of surface utility boxes, such that boxes fall entirely within either a paved surface or entirely within a planted surface but not partly in paving and partly in planting and that grades and alignment of boxes match the final design and construction of all elements to create a co-coordinated and orderly appearance, free of trips and hazards.

6.5 Plant Material

6.5.1 Urban Trees in Pavement

Select and site urban trees in pavement to eliminate long term above-ground and below ground conflicts with utilities, buildings and structures, and pedestrian and vehicular traffic.

6.5.2 Planting Details and Procedures

Landscape Drawings shall specify the appropriate planting detail standard from the Village Standard Details.

6.5.3 Planting Provisions in Single Family Subdivisions

Street trees and landscape finish of the public road fronting occupied homes shall be completed no later than the date that 85% of the homes in a single-family development are completed and occupied. Earlier completion dates are encouraged if landscape maintenance and repair is provided at no cost to the Village until such time as units are occupied.

Planting of street trees in the hot dry summer period of June, July and August is discouraged, due to the risk of failure of the planting caused by heat and drought.

Minimum number of boulevard trees shall be calculated as follows:

- Large Trees - Greater of 1 per Lot or 12-15m OC Spacing
- Medium Trees - Greater of 1 per Lot or 9-12m OC Spacing
- Small Trees - Greater of 1 per Lot or 6-9m OC Spacing
- Plantings of trees closer than 6m on center shall require the written concurrence of the Village
- Locate trees fronting on single family lots in locations that avoid all utility service alignments and driveways. Generally, this will lead to tree placement in the half of the lot frontage away from the driveway side, and not at either the lot centreline or at a lot line

6.5.4 Plant Material Selection

6.5.4.1 Plant Materials

- Plants shall have the ability to withstand adverse conditions such as airborne pollutants, maximum sun exposure and reflected heat from pavements, high winds and abrasive forces, occasional snow loading and exposure to salt from road clearing operations, and limited root zone soil volumes
- Plants shall be capable of reduced water demand following a one-year establishment period
- Plants shall have relatively low maintenance attributes including: fine to medium leaf size and canopy density; non-fruit bearing or having only berry-sized, non-staining and non-toxic fruits; low susceptibility to disfiguring or fatal diseases and infestations; infrequent demands for pruning, fertilizing and other cultural requirements

6.5.4.2 Lawns/Fine Grass, Rough Grass and Wildflowers

- Sod shall be used on all lawn/fine grass areas. Seeding, as an alternate, shall require approval of the Village
- Rough grass and wildflower areas shall be seeded. Seeding method shall be noted on drawings

- Areas to be seeded with grades greater than 3:1 and/or highly erodible soils shall be hydroseeded with a nurse crop seed mix, a hydraulically applied erosion control mulch, or erosion control blanket. Erosion control method to be noted on drawings

6.5.4.3 Trees

- Boulevard or 'street' trees shall be of a single species/cultivar on either side of the street within a given block. Median tree species may vary.
- Street tree species shall vary between intersecting streets. Street tree selection will be made with consideration of maintaining a diverse and varied street tree distribution across a neighbourhood to minimize disease risks.
- All street trees:
 - Shall have a single straight trunk, a well-developed leader free of co-dominant stems or competing vigorous upright branches, with tops and roots characteristic of the species cultivar or variety
 - Shall be healthy, vigorous, well rooted, have an established root system reaching the size of the container to maintain a firm ball when the container is removed, but shall not have excessive root growth encircling the inside of the container
 - Must be free of insects, disease, mechanical injury, and other objectionable features when planted
 - At time of inspection or delivery, shall show no signs of moisture stress from under or over watering, as indicated by wilted, shriveled or dead leaves or branch die back.
 - Shall be free of pernicious weeds in the root ball
 - Shall be free of girdling roots

6.5.4.4 Street Tree Size, Spacing and Location

Trees shall be minimum:

- Large Trees - 7 cm caliper
- Medium Trees - 6 cm caliper
- Small Trees – 5 cm caliper

Each tree shall have a sturdy, reasonably straight trunk and a well-developed leader. Each tree shall have a well-balanced branching head with the branches growing out from the stem with reasonable symmetry.

6.5.4.5 Preferred Street Tree Species List

Landscaping design shall blend with existing Plantings. Tree species shall differ from one street to the next. Changes should typically occur at intersections. Trees planted in proximity to overhead wires shall be limited to shorter species.

The selection of tree species to be used in a Subdivision or Development shall be determined by the Village prior to commencing design. The Owner shall not make substitutions without the expressed written approval of the Village.

The lists shown in Tables 6-1 to 6-5 are to be used only as a general guide. Other species/cultivars may do well on streets.

Large Trees

Trees over 15m in height and 7.5m in width. Suitable for boulevards with no overhead obstructions and > 3m of width.

Table 6-1 - Large Tree Species List

Botanical Name	Common Name
Acer Platinoids	Norway Maple
Acer Cappadocicum	Cappadocicum Maple
Fagus Sylvatica	European Beech
Fraxinus Americana	American Ash
Ginkgo Biloba	Maidenhair Tree
Magnolia Grandiflora	Southern Magnolia
Metasequoia Glyptostroboides	Dawn Redwood
Quercus Acutissima	Sawtooth Oak
Quercus Palustris	Pin Oak
Quercus Phellos	Willow Leaf Oak
Robinia Pseudoacacia 'Frischia'	Golden Black Locust
Tilia Tomentosa	Silver Linden
Zelcova Serrata 'Green Vase'	Zelcova

Medium Trees

Trees maturing between 8m and 15m are generally suitable for situating on a blockside tree lawn 1m or greater between curb and sidewalk.

Table 6-2 – Medium Tree Species List

Botanical Name	Common Name
Acer Campestre 'Queen Elizabeth'	Campestre Maple
Acer Pennsylvanicum	Moosewood
Acer Rubrum	
'October Glory" Autumn Blaze' 'Autumn Flame'	Red Maple
Acer Truncatum	Truncatum Maple
Carpinus Betulus	European Hornbeam
Corylus Columna	Turkish Hazel
Davidia Involucrata	Dove Tree
Fraxinus Ornus	Flowering Ash

Gleditsia Triacanthos	Honey Locust
Magnolia Kobus (Root Stock)	Japanese Magnolia
Nyssa Sylvatica	Black Tupelo
Parrotia Persica	Persian Persica
Prunus Yedoensis 'Akebono'	Yoshino Cherries
Sorbus Alnifolia	Korean Mountain

Small Trees

Trees maturing 6-8m. Suitable for locating at or below overhead electrical conductors

Table 6-3 – Small Tree Species List

Botanical Name	Common Name
Acer Griseum	Paperbark Maple
Acer Platanoides 'Globosum'	Globe Maple
Amelanchier Canadensis 'Princess Dianna'	Tree Form Service Berry
Cercis Canadensis	Eastern Redbud
Cornus Nutalli 'Eddies White Wonder'	Eddies White Wonder
Cornus Kousa 'Chinesnis' 'Satomi'	Japanese Dogwood
Crataegus crus-gali var. inermis	Cockspur Thornless Hawthorn
Hibiscus Syriaca	Tree Form Hibiscus
Malus X Floribunda (Disease Resistant Cultivar Recommendations Available)	Flowering Crabapple
Magnolia Stellata	Star Magnolia
Stewartia monodelpha	Orange Bark Stewartia
Stewartia pseudocamelia	Japanese Stewartia
Styrax Japonica	Japanese Snowbell
Syringae Reticulata	Tree Lilac

Columnar Trees

Trees exhibiting a distinct upright branch arrangement. Suitable for locating in confined situations or on tree lawns offset from overhead electrical conductors.

Table 6-4 – Columnar Tree Species List

Botanical Name	Common Name
Acer Nigra 'Green Column'	Black Maple
Acer Platanoides 'Columnar' 'olmstead'	
'Crimson Sentry' 'Cleveland'	Columnar Norway Maple
Acer Rubrum	
Karpick "bohalla", 'Scarlet Sentinel'	Upright Red Maple
Acer Freemanii	
'Scarlet Sentinel' 'Armstrong'	Freeman's Maples
Carpinus Betulas 'Fastigiata'	European Hornbeam

Fagus Sylvatica 'Dawycki'	Dawycki Beech
Gingko Biloba 'Sentry'lakeview'	Ginko Tree (Maidenhair)
Parrotia Persica 'Vanessa' ,	
' Inges Ruby Vase'	Upright Parrotia

Conifers

Cone bearing trees are not generally planted on boulevards due to their low branching habit when young. Nonetheless, they are a desirable type of tree top plant where space allows. Traffic medians are often suitable. Below are some typically specified species.

Table 6-5 – Conifers Tree Species List

Botanical Name	Common Name
Calocedrus Decurrens	California Incense Cedar
Cedrus Atalntica 'Glauca'	Blue Atlas Cedar
Cedrus Deodar 'Kashmir'	Deodar Cedar
Chamaecyparris Nootkatensis	Nootka Cypress
Pinus Nigra	European Pine
Picea Omerika	Serbian Spruce
Thuja Plicata	Western Red Cedar

6.5.4.6 Street Tree Soil Volumes

Trees for directly under Hydro lines

- Minimum allowable soil volume per tree is 4 cu.m. with 1m depth pit
- Mature height not greater than 7.62m.

Trees for beside hydro lines

- Minimum lateral distance from nearest line 2.75m
- Minimum allowable soil volume per tree is 4 cu.m. with 1m depth pit
- Mature spread not greater than 5m

Trees for limited available soil volume

- Minimum allowable soil volume per tree is 4 cu.m. with 1m depth pit
- Mature height not greater than 10m

Trees for available soil volumes of 9 cu. m. or greater

- 1m pit depth
- Mature height not greater than 20m

Trees for a wide boulevard or wide median use only

- Minimum available root zone of 20 cu.m. per tree
- Minimum boulevard or median width of 3.5m

6.5.4.7 Minimum Setbacks for Trees

Setbacks for trees to objects shall be as follows. Alternate setbacks maybe used with written approval of the Village.

Table 6-5 – Minimum Tree Setbacks

Setback Trees From:	Distance
Underground street light conduit or irrigation main	0.6m
Other underground utilities	1.2m
Lamp standards	6.0m
Steel and wooden utility poles	3.0m
Driveways	1.5m
Catch basins	1.5m
Manholes, valve boxes, services	3.0m
Sewer service boxes	2.0m
Fire hydrants	2.0m
Road intersection	8.0m
Curb face	1.0m
Sidewalk	0.8m
Curb face and sidewalk with root barrier	0.6m
Buildings - fastigate (columnar) tree	2.0m
Buildings - regular crown tree	3.0-5.0m

The Village may consider custom setbacks where trees are being installed in existing streets with established utilities.

6.6 Landscape Maintenance Schedule

The Owner's qualified professional shall submit a maintenance schedule with the Certificate of Substantial Performance. It shall include timing and arrangements for:

- Routine inspection
- Aerating and dethatching turf areas
- Replenishing mulch
- Fertilizing
- Pruning
- Weeding

The project applicant is encouraged to implement sustainable or environmentally-friendly practices for overall Landscape maintenance.

6.7 Irrigation Design

The Applicant shall appoint a Qualified Professional to create and submit an Irrigation Plan and supervise installation to produce an irrigation system that:

- Groups irrigation circuits/zones into 'hydro-zones' of high, medium and low or unirrigated areas consistent with the landscape planting plan
- Uses reclaimed or recycled water or rainwater capture from roofs or rain barrels for outdoor water use when such is available, as a substitute for use of potable water
- Minimizes use of high-volume spray heads and employs drip or low volume irrigation where practical to meet the watering needs of hydro-zones
- Uses surface or subsurface drip irrigation or low volume irrigation technology to water long, narrow or irregularly shaped areas including turf areas less than 2.4m in width
- Keeps drip, spray and rotor heads (different precipitation rates) on different irrigation circuits
- Designs with irrigation head-to-head coverage in accordance with manufacturer's specifications
- Ensures matched precipitation rates on each irrigation circuit
- Minimizes the elevation change in each irrigation circuit—and where required provides pressure compensating devices to minimize pressure variations or check valves to stop low head drainage
- Ensures irrigation mainlines are proved leak-free with hydrostatic tests, as a part of the construction quality assurance review. Re-test irrigation mainlines after major repair or nearby excavation work
- Provides pressure regulating devices to ensure irrigation outlets are operating at the manufacturer's optimum pressure range
- Designs head placement and type, and adjusts head radius, arc and alignment to avoid overspray of paved surfaces or buildings
- If irrigating slopes greater than 25%, designs an irrigation system with a precipitation rate not greater than 20mm/hour
- Provides automatic shut off devices that shut off the system in cases of pipe leak or breakage, and that shut off the system when rain is present
- Installs - and programs to minimize water use – one or more 'Smart Controllers' with water-conserving functions. Includes a written Irrigation Schedule or equivalent instructions for operation of the Smart Controller, with a copy stored with the controller cabinet, that adjusts the amount of applied water scheduled to be applied on a daily basis- schedule different run-times as weather changes, by using the weather-sensitive features of a Smart Controller. In cases where manual irrigation program adjustment is temporarily required, adjust water programming at least once per month to recognize that highest water need is in July and lower water needs exist in other months of the growing season

- Ensures irrigation design and installation standards including adjustments and scheduling meet the requirements of the irrigation specifications provided by the Qualified Professional
- Includes the following written declaration signed by a Certified Irrigation Designer qualified by the Irrigation Industry Association of BC (IIABC):
 - At the time of substantial performance of the construction: "This irrigation installation complies substantially with the submitted water conservation and irrigation plans, specifications and reports".

6.7.1 Irrigation - As Constructed Drawings

As-constructed irrigation plans shall be provided acceptable to the Village prior to award of substantial performance.

Provisions for watering of planted trees, shrubs, groundcover and fine grass areas shall be made by the Owner on all lands to be dedicated as park or road right of way to the Village.

All Irrigation Design shall follow these guidelines:

- Landscape medians in urban settings shall be irrigated unless an alternative proposal is approved by the Village
- In grassed boulevards fronting institutional, commercial and multifamily residential uses with potential for heavy pedestrian traffic between the curb and sidewalk, grass areas shall be irrigated. Low traffic grassed boulevards in single family neighbourhoods may be installed without irrigation, but manual watering for establishment and maintenance is required. The Village decision on irrigation requirements for grass areas shall be final
- Boulevard trees, shrubs and ground covers shall be watered from an automatic irrigation system unless an alternative proposal is approved by the Village
- Urban trees in pavement shall be irrigated with an automatic irrigation system that may include bubblers or drip elements
- Irrigation systems shall be designed to provide water conservation by employing a soil moisture probe, weather station, or other devices to override the controller during periods of adequate soil moisture or rainfall
- Point source drip irrigation (no grid layouts) or high efficiency irrigation heads shall be used on all shrub beds
- Underground drip line grids may be used on turf areas where planted area is less than 2m wide
- Sleeves shall be provided under sidewalks and driveways, and to medians/islands, as required for installation and maintenance of the irrigation system without removing surface paving
- Maximum design flow velocity to be 1.5 m/s
- Size pipes and valves for minimum friction loss

- Provide an isolation gate valve upstream of all automatic sprinkler valves
- Design head-to-head coverage for turf and shrub areas
- Design to water plant materials with different watering requirements (e.g. grass vs. shrub areas) on different valve circuits
- Design sprinkler circuits with matched precipitation heads. Do not mix heads with varied precipitation rates on the same circuit
- Specify low flow heads for sloping areas. Design sprinkler circuits to minimize elevation changes within the circuit
- Where surface sprinklers are used, ensure unobstructed sprinkler coverage to tree bases from at least two sides
- Every drip circuit shall be designed with a filter, pressure regulator, flush valve and air relief valve. The drip component manufacturer's instructions for installation and maintenance shall be included in the project specifications
- Tracer wire should be installed on all mains
- Minimize overspray on paved surfaces. Do not overspray building walls or unvegetated rooftops
- Maintain and repair irrigation systems for the duration of the maintenance period. Provide winterization and spring start-up as required in the maintenance period
- Locations shall be staked out by the Owner according to accepted plans and verified on site by the Village prior to planting. If underground obstructions are uncovered, they shall be reported to the Village for resolution

7 ELECTRICAL

CONTENTS

7	ELECTRICAL	7-1
7.1	General	7-2
7.2	Rules and Regulations	7-2
7.3	Conduits	7-2
7.4	Electrical	7-2
7.5	Street Lighting	7-2
7.6	Communication Wiring	7-4
7.7	Overhead/Underground Requirements	7-4
7.8	Kiosk Coating Requirements	7-5

DRAFT

7.1 General

The electrical systems must be installed at the Owner's expense, in accordance with the requirements of the appropriate utility company.

Underground electrical services are required unless overhead distribution is approved by the Village. Where overhead distribution is permitted, pole and anchor locations must be approved by both the Village and the appropriate utility company. Care must be taken to avoid aerial trespass.

Plans and agreements for rights of way for anchors, pad-mounted transformers, etc., must be provided and registered at the expense of the Owner.

All standard drawings as per MMCD Series E – Standard Detailed Electrical Drawings

7.2 Rules and Regulations

Equipment, installation, wiring methods, and materials used must be in accordance with the Rules and Regulations for the Installation and maintenance of Electrical Equipment as issued by the Ministry of Transportation & Highways, Province of British Columbia. Work must also be in accordance with all applicable municipal codes and regulations, provincial statutes or regulations in effect at the site.

7.3 Conduits

Conduits must be installed, as nearly as possible, at a constant depth and on the alignment shown on the Standard Drawings. Conduits under existing paved roads, driveways, or sidewalks must be installed using a trenchless method unless the Village give express written consent for open trenching prior to the commencement of the work.

7.4 Electrical

Electrical systems must be provided to serve each lot within the Subdivision. The location of all facilities and structures must be in accordance with the engineering drawings as approved by the Village and must be clearly indicated on the plans.

7.5 Street Lighting

Level of Illumination: The "Maintained illuminance Uniformity Levels" as recommended by the Illumination Engineering Society (IES) shall be as follows in Table 7-1:

TABLE 7-1 - Level of Illumination

Road Classification	Area Classification	Average Maintained Illuminance in Lux	Illuminance Uniformity Ratio
Arterial	Commercial	17	3 to 1
	Intermediate Residential	13 9	
Collector	Commercial	12	4 to 1
	Intermediate Residential	9 6	
Local	Commercial	9	6 to 1

7.5.1 Area Classification

Commercial: All areas that are zoned as Commercial. Examples are Roadways adjacent to shopping centres, central business districts, Village town centres, Motels and Hotels.

Intermediate: Areas that are zoned as High-Density Multi-Family, Local Commercial, Industrial, and Public. Transportation area between commercial and residential areas of up to 500 m in length.

Residential: Areas that are zoned as Rural-Residential, and Single Family Residential to Medium Density Multi-Family Residential.

Notes: Lux is defined as illuminance and is expressed in lumens per square meters. Foot Candles has been the previous measurement term. For conversion purposes 1 Lux = .09 Foot Candle.

7.5.2 Roadway Classification

Arterial: A Roadway that serves as a continuous route primarily for inter community through traffic.

Collector: A Roadway that performs the dual function for traffic of land access and traffic movement between arterial and local roads.

Local: A Roadway that provides direct land access and is not intended to carry through traffic.

7.5.3 Street Light Colour Temp

Street lights must be colour temp as follows:

- Residential areas 3,000 k
- Commercial areas 4,000 k

7.5.4 Security Plate

All street lights to be installed with security plate for access port. The locking bolt pattern shall be in a pattern specified or approved by the Village.

7.5.5 Pole Locations

In general, the layout for pole installation must be as follows:

- Divided Arterial Roadways:
 - Four (4) Lane road width < 22 m staggered spacing.
 - Six (6) Lane road width > 22 m. Treat each three Lane portions of divided Roadway as two separate roads. One sided or staggered spacing.
- Undivided Arterial Roadways two (2) to four (4) Lanes. Staggered spacing.
- Collector Roadways - staggered spacing.
- Local Roadways - staggered or one sided spacing.

Poles must be located within 0.6 m of the property corners where possible and must not conflict with driveways and underground utilities. Pole layout must be based from the intersections.

7.6 Communication Wiring

The owner must make arrangements with the appropriate communication and cable T.V. company for installation of services in accordance with the requirements of these utilities.

Underground Telephone and Cable TV, where installed, must be sufficiently complete prior to construction of sidewalks, curbs and gutters and street paving, to avoid damage to these improvements.

7.7 Overhead/Underground Requirements

The Village's requirements for allowing overhead or underground wires is as follows:

- In all Town Center and Village Center areas as identified by the Official Community Plan all wires shall be buried and installed in conduits.
- All streets and highways that are created as a result of new development shall have all wires buried underground.
- Outside of these areas where existing overhead wires parallel the existing road the Owner shall have the option to bury or to leave overhead the wires.
- On roadways identified in the Village's 20 Year Servicing Plan for upgrade and urbanization, all service wires crossing the roadway must be buried.

7.8 Kiosk Coating Requirements

Anti-graffiti coating to be applied to all utility kiosks. Alternatively, kiosks to be wrapped with anti-graffiti vinyl wrapping. Wrap material shall be a cast vinyl then laminated with a high gloss laminate.

DRAFT

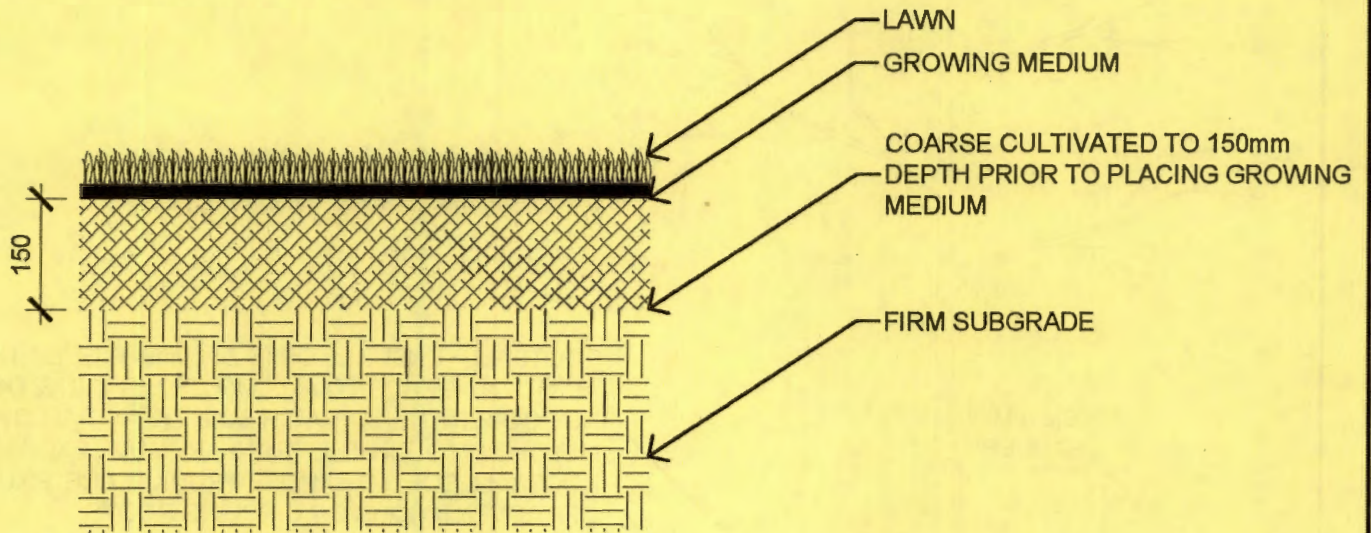

March 14, 2022



HARRISON HOT SPRINGS

Naturally Refreshed

Growing Medium Lawn

DWG. No.

L-0127

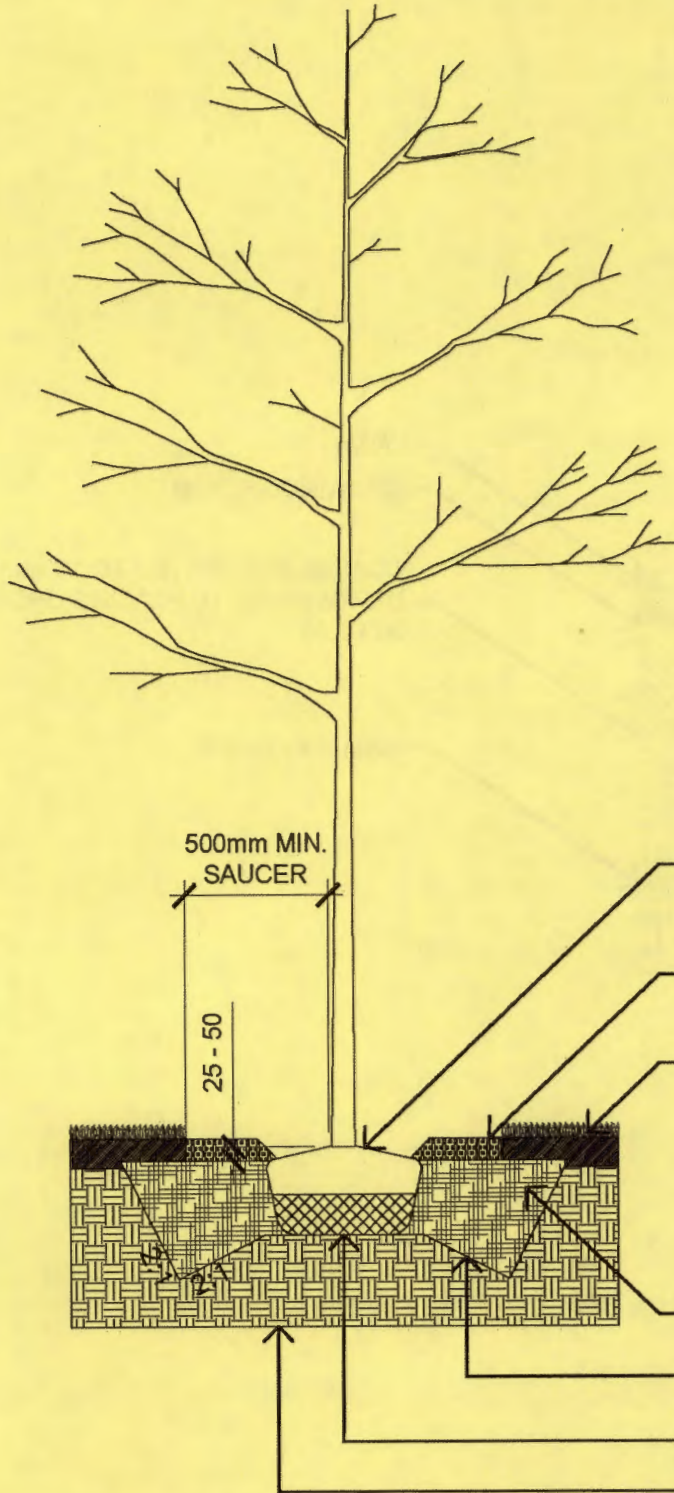

NOTES:

1. DO NOT STAKE OR WRAP TREE UNLESS TO ALLOW FOR LOCALIZED TREE SWING.
2. USE ROOT BARRIER ALONG EDGE OF PLANTING BED WHERE TREE TRUNK IS WITHIN 2.0m OF HARD SURFACE.

ROOTBALL - ENSURE TOP IS 25-50mm HIGHER THAN ADJACENT GRADE TO ALLOW FOR SETTLING. DO NOT COVER THE TOP WITH SOIL. DO NOT ALLOW MULCH TO TOUCH THE TRUNK. REMOVE EXCESS ROOTBALL SOIL TO EXPOSE TRUNK FLARE. PRUNE OFF ADVENTITIOUS OR CIRCLING ROOTS.

75mm DEPTH MULCH ALL AROUND

GRASS

GROWING MEDIUM ALL AROUND

SCARIFY TO 150mm DEPTH THE ENTIRE TREE PIT PRIOR TO PLACING GROWING MEDIUM

TAMP SOIL AROUND BASE OF ROOTBALL.

DO NOT EXCAVATE BELOW ROOTBALL

FIRM SUBGRADE

March 14, 2022

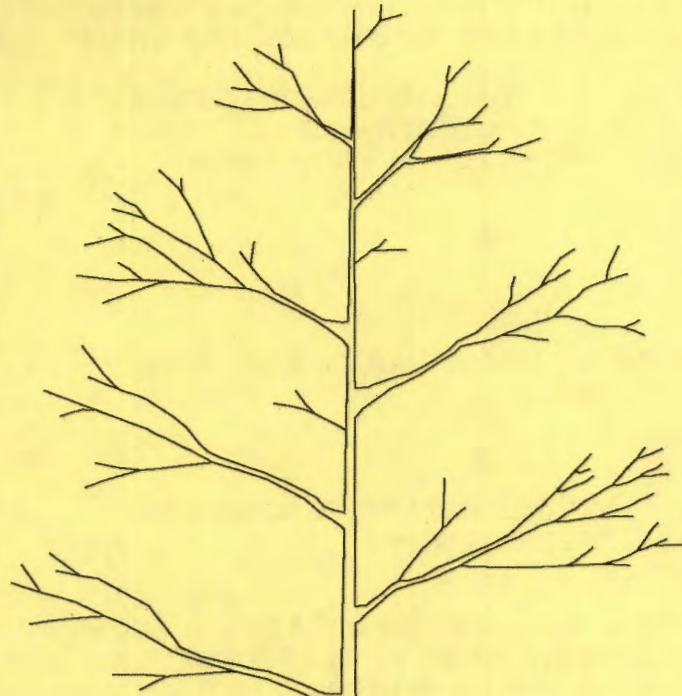

NOTES:

1. DO NOT STAKE OR WRAP TREE UNLESS TO ALLOW FOR LOCALIZED TREE SWING.
2. USE ROOT BARRIER ALONG EDGE OF PLANTING BED WHERE TREE TRUNK IS WITHIN 2.0m OF HARD SURFACE.

ROOTBALL - ENSURE TOP IS 25-50mm HIGHER THAN ADJACENT GRADE TO ALLOW FOR SETTLING. DO NOT COVER THE TOP WITH SOIL. DO NOT ALLOW MULCH TO TOUCH THE TRUNK. REMOVE EXCESS ROOTBALL SOIL TO EXPOSE TRUNK FLARE. PRUNE OFF ADVENTITIOUS OR CIRCLING ROOTS.

75mm DEPTH MULCH ALL AROUND

GRASS

GROWING MEDIUM ALL AROUND

SCARIFY TO 150mm DEPTH THE ENTIRE TREE PIT PRIOR TO PLACING GROWING MEDIUM

TAMP SOIL AROUND BASE OF ROOTBALL
DO NOT EXCAVATE BELOW ROOTBALL

FIRM SUBGRADE

March 14, 2022

HARRISON HOT SPRINGS

Naturally Refreshed

Tree - In Planting Bed

DWG. No.

L-03
129

NOTES:

1. DO NOT STAKE OR WRAP TREE UNLESS TO ALLOW FOR LOCALIZED TREE SWING.
2. USE ROOT BARRIER ALONG EDGE OF PLANTING BED WHERE TREE TRUNK IS WITHIN 2.0m OF HARD SURFACE.

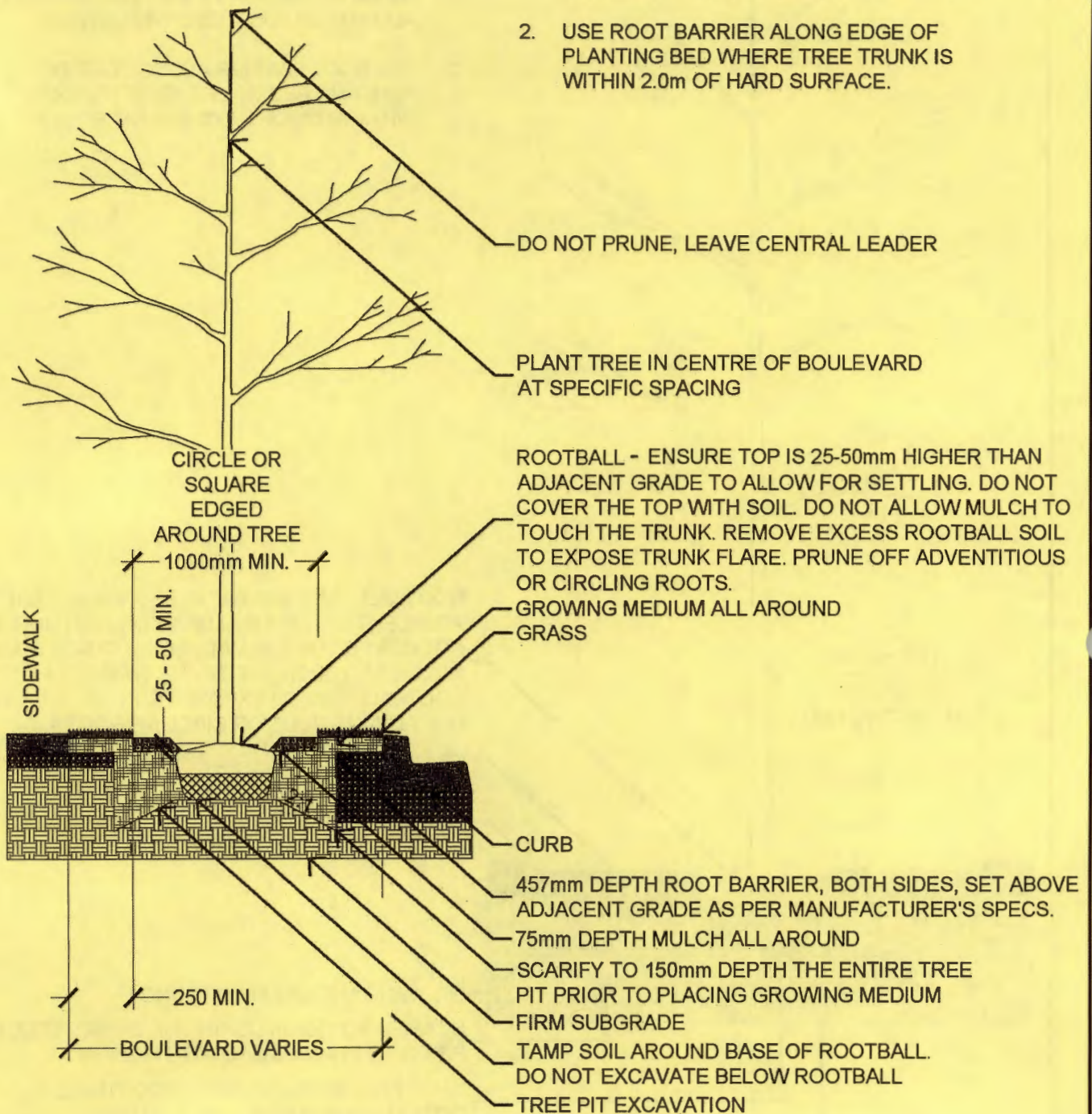

March 14, 2022

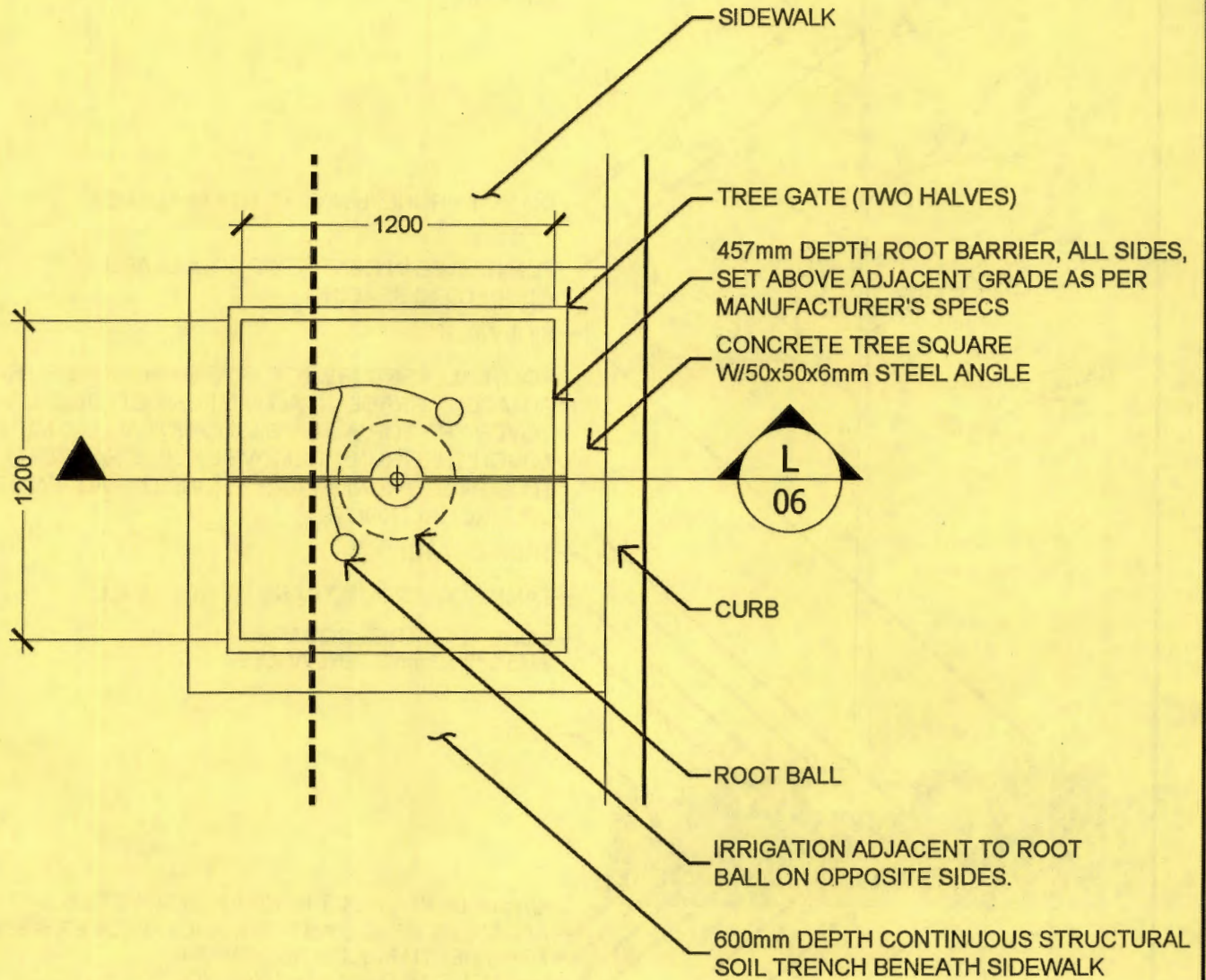

March 14, 2022

NOTES:

1. DO NOT STAKE OR WRAP TREE UNLESS TO ALLOW FOR LOCALIZED TREE SWING.
2. USE ROOT BARRIER ALONG EDGE OF PLANTING BED WHERE TREE TRUNK IS WITHIN 2.0m OF HARD SURFACE.

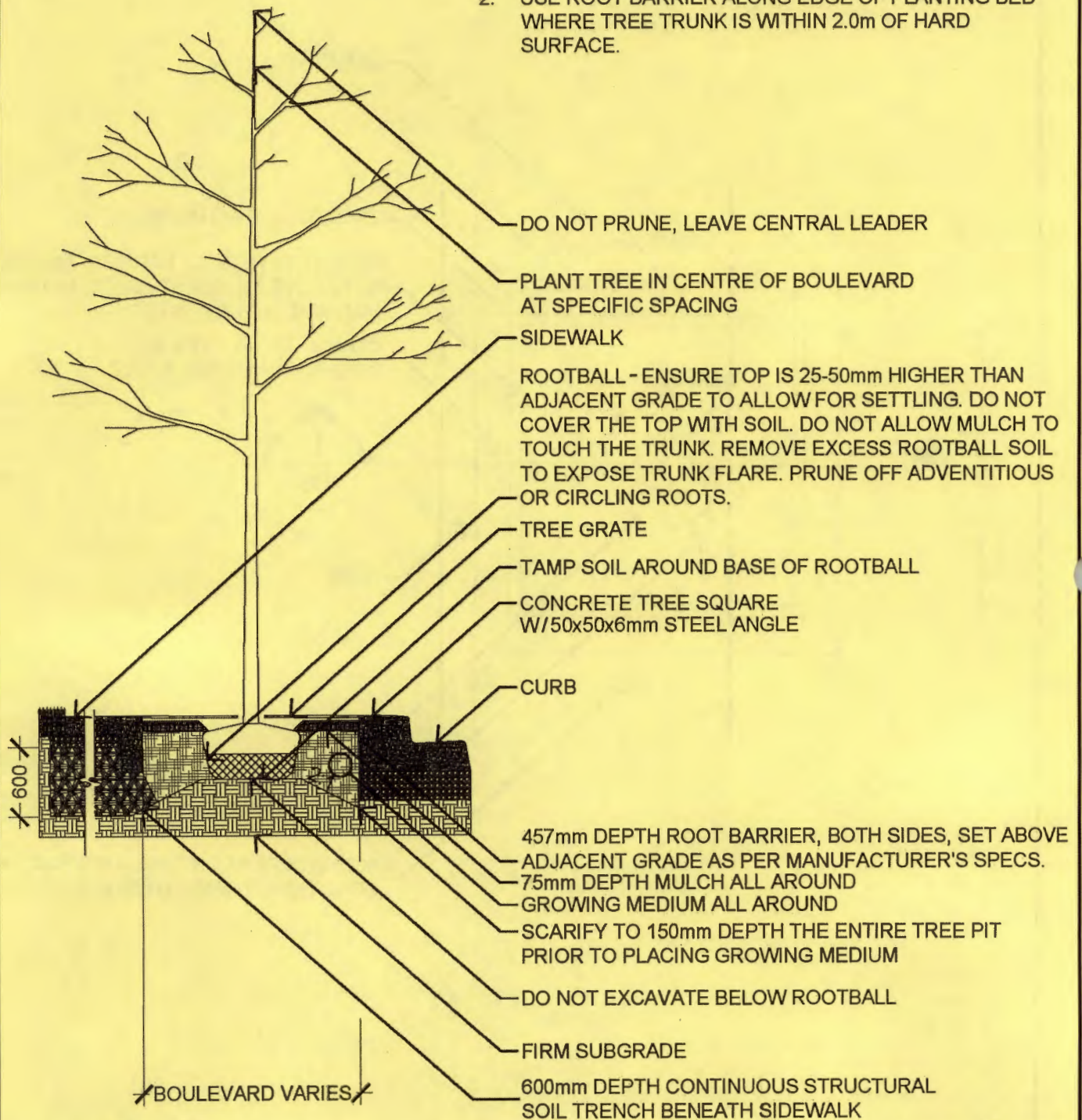

March 14, 2022

NOTES:

1. DO NOT STAKE OR WRAP TREE UNLESS TO ALLOW FOR LOCALIZED TREE SWING.
2. USE ROOT BARRIER ALONG EDGE OF PLANTING BED WHERE TREE TRUNK IS WITHIN 2.0m OF HARD SURFACE.

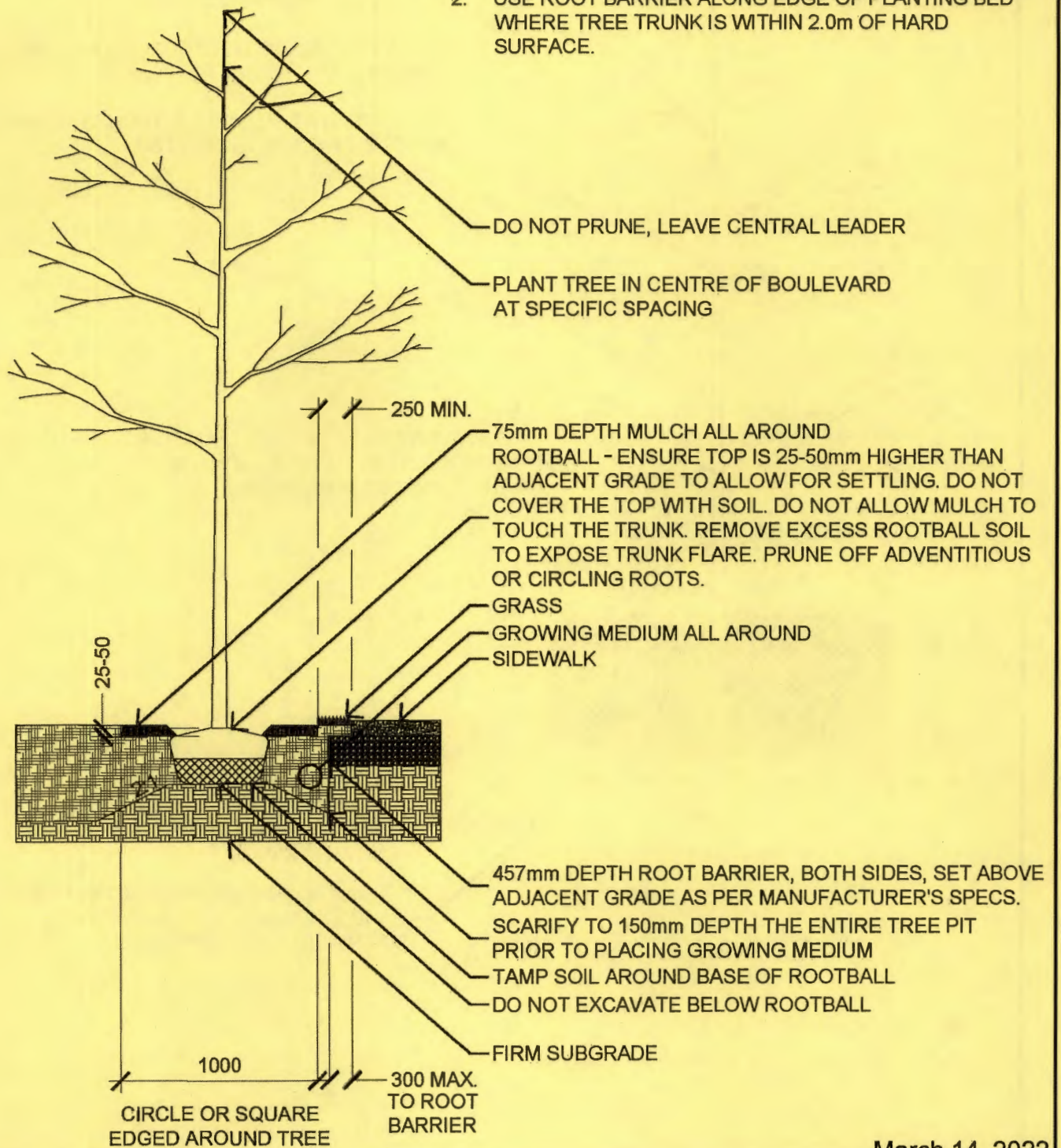

March 14, 2022

NOTES:

1. USE SNOW FENCING FOR PROTECTION FENCE.
2. SNOW FENCING TO BE SECURED BY METAL STAKES.
3. FLAGGING TAPE MUST BE ATTACHED TO FENCE TO HIGHLIGHT PROTECTION ZONE.

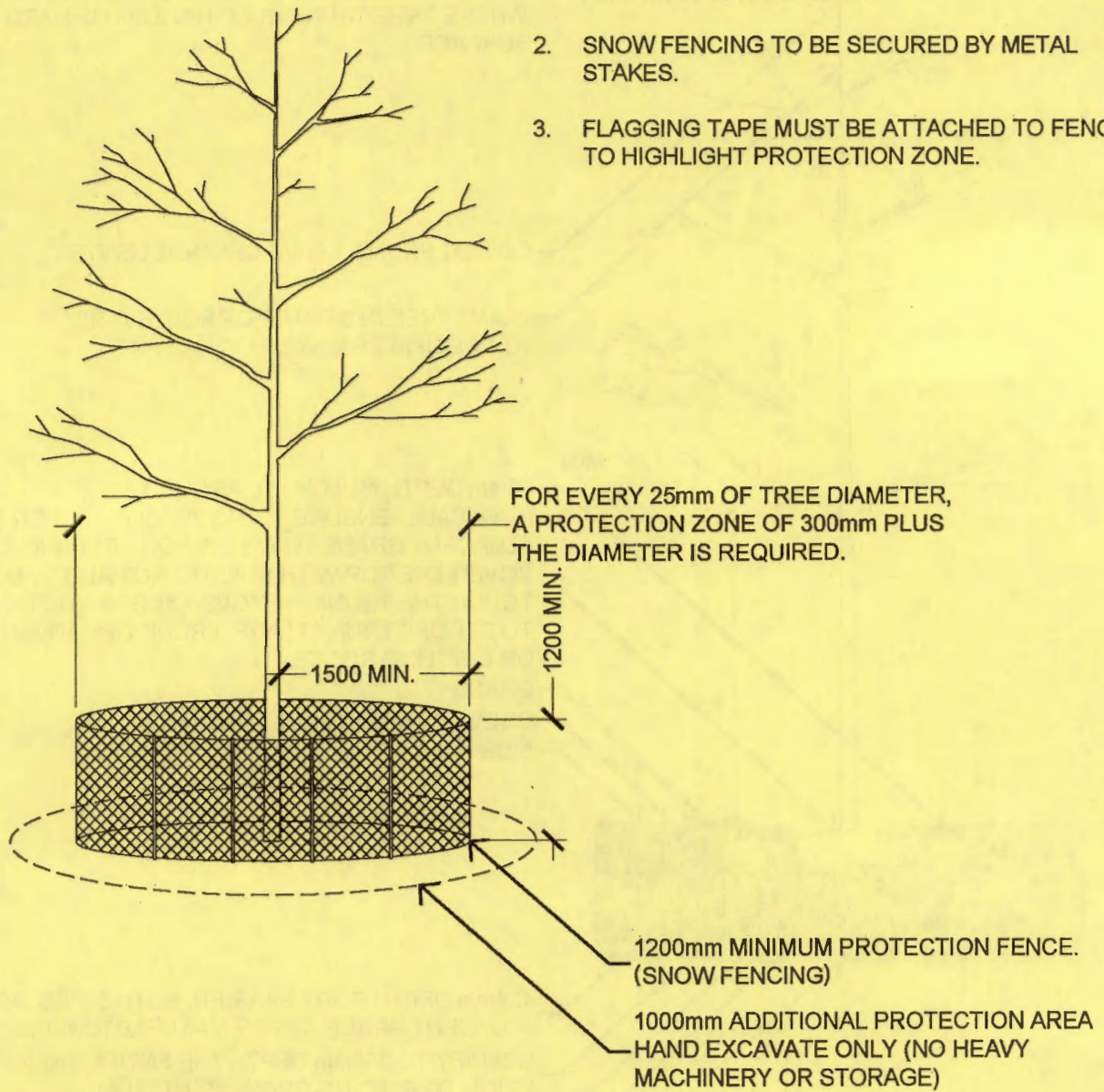

March 14, 2022

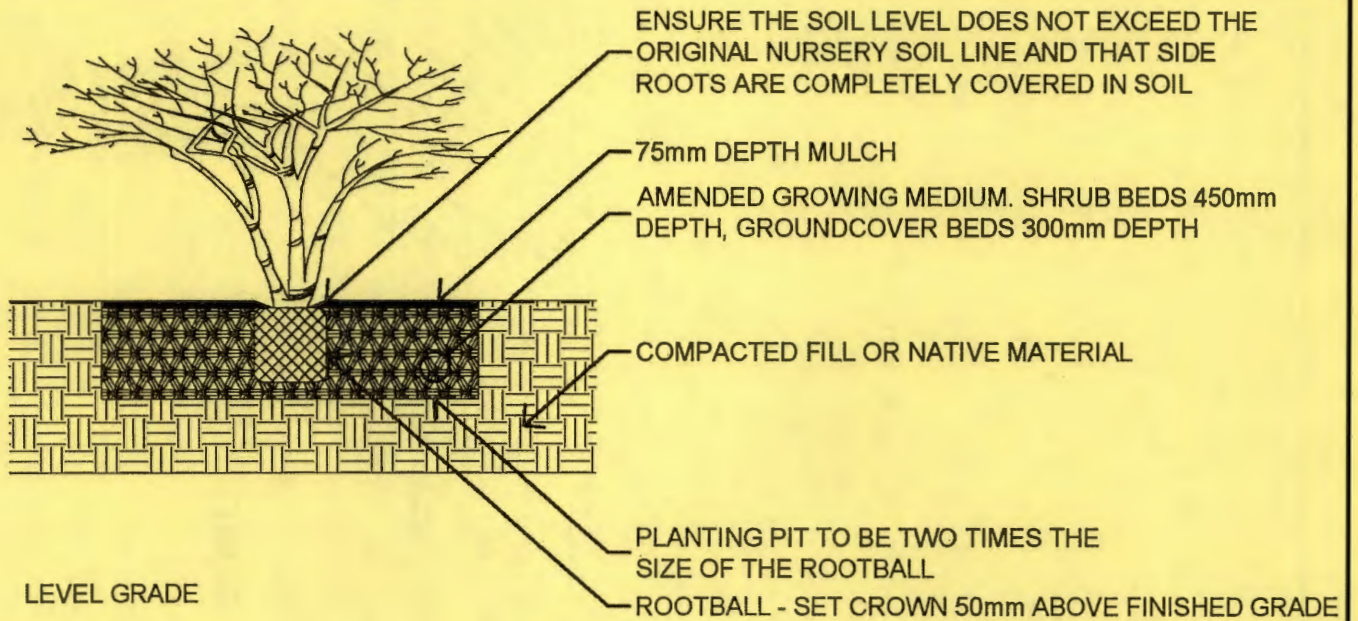
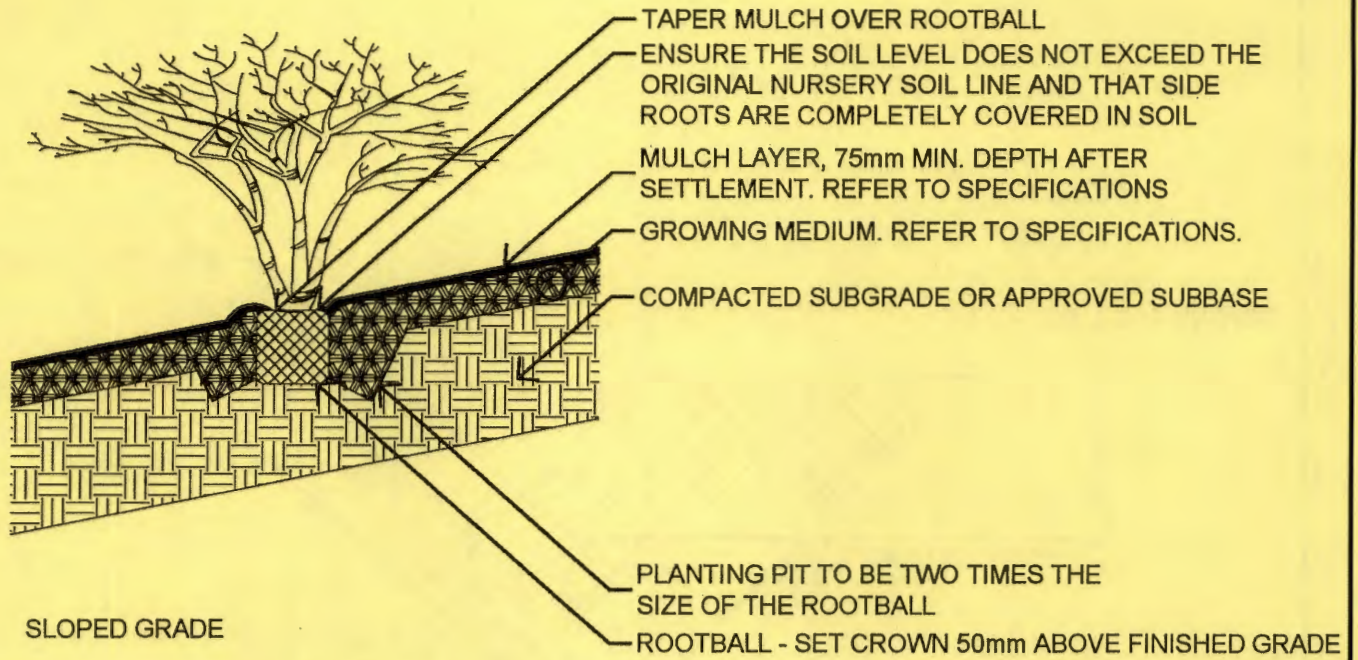

NOTES:

1. ALL DEPTHS ARE COMPACTED MATERIALS.

March 14, 2022

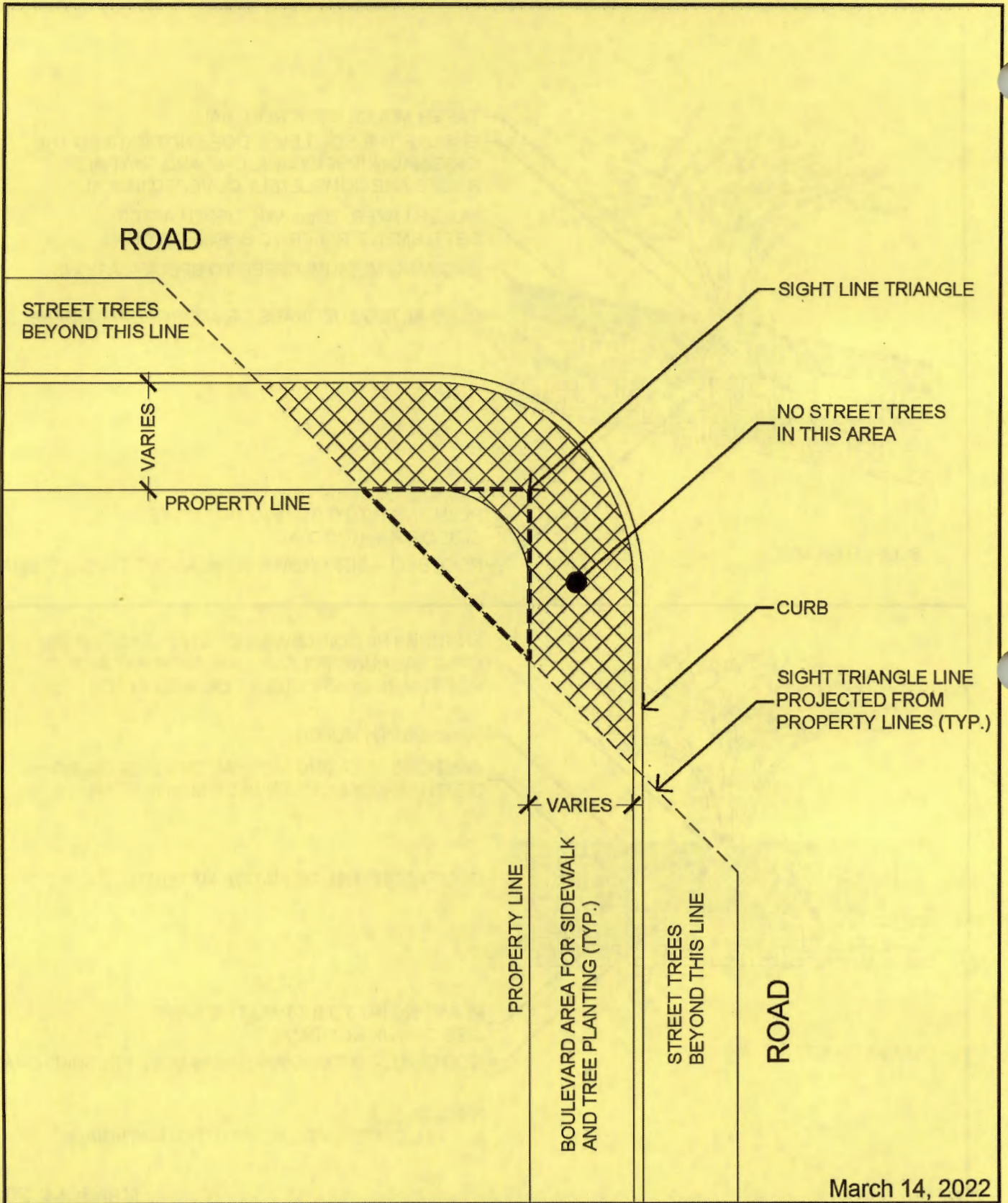

HARRISON HOT SPRINGS

Naturally Refreshed

Street Tree Locations at Intersections

DWG. No.
L-10

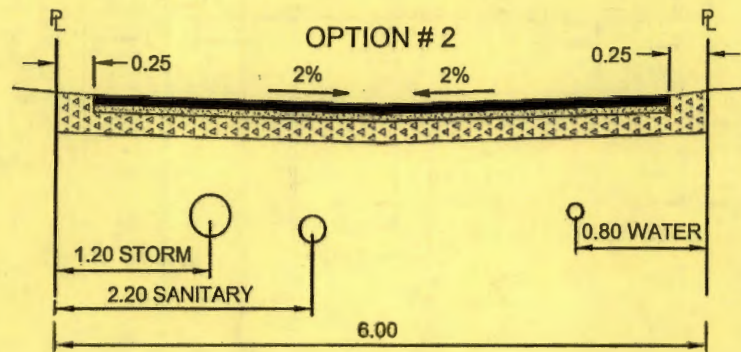
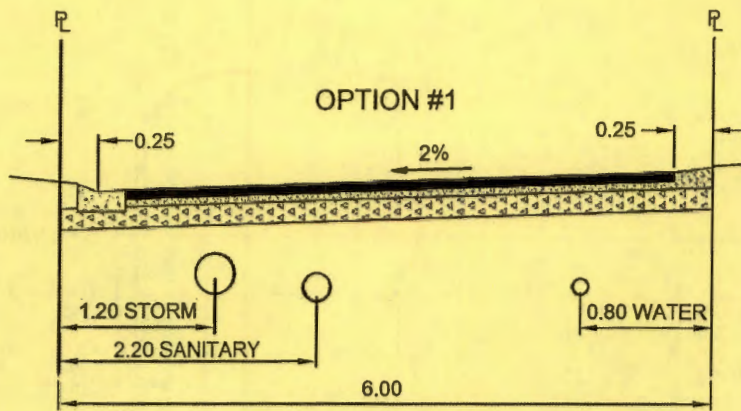

MIN 65mm ASPHALT COURSE
 MIN 100mm OF 20mm MINUS CRUSH
 BASE TO 95% MODIFIED PROCTOR
 MIN 200mm OF 75mm MINUS GRAVEL SUBBASE
 TO 95% MODIFIED PROCTOR
 SUBGRADE TO 90% MODIFIED PROCTOR

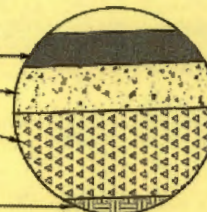

NOTES :

1. THE STRUCTURAL ROAD ELEMENTS SHOWN ARE THE MINIMUM REQUIREMENTS. SOILS TEST RESULTS SHALL BE USED TO DESIGN THE ROAD STRUCTURE.
2. ALL UTILITY SERVICES AND SERVICE CONNECTIONS SHALL BE INSTALLED PRIOR TO FINAL PAVING.
3. ANY PERMANENT WORKS ON PRIVATE PROPERTY SHALL BE PROTECTED BY A REGISTERED EASEMENT OR RIGHT OF WAY.
4. WHERE THE DEPTH OF ANY UTILITY PROPOSED TO BE LOCATED WITHIN THE LANE IS GREATER THAN 1.0 m FROM THE LANE SURFACE, AND WHERE MORE THAN ONE UTILITY IS PROPOSED FOR INSTALLATION, PRE-APPROVAL FROM THE VILLAGE ENGINEER IS REQUIRED.

UNIT = METERS & DECIMALS

March 9, 2022

HARRISON HOT SPRINGS
Naturally Refreshed

6.00m LANE

DWG. No.
R-01

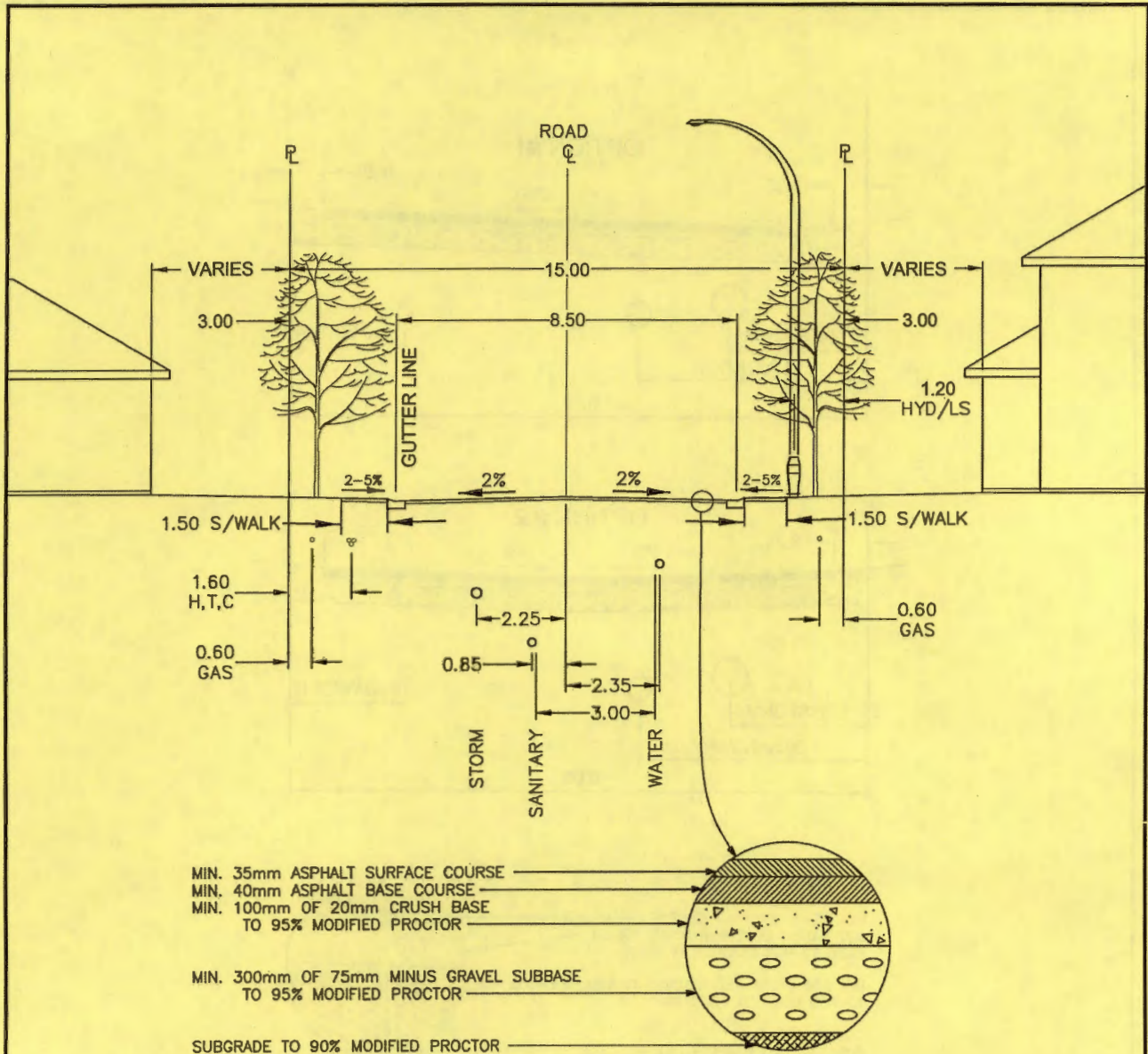

NOTES:

1. THE STRUCTURAL ROAD ELEMENTS SHOWN ARE THE MINIMUM REQUIREMENTS. SOILS TEST RESULTS SHALL BE USED TO DESIGN THE ROAD STRUCTURE.
2. ALL UTILITY SERVICES AND SERVICE CONNECTIONS SHALL BE INSTALLED PRIOR TO FINAL PAVING.
3. ANY PERMANENT WORKS ON PRIVATE PROPERTY SHALL BE PROTECTED BY A REGISTERED EASEMENT OR RIGHT OF WAY AS DETERMINED BY THE VILLAGE

UNIT = METERS & DECIMALS

March 9, 2022



**LOCAL ROAD - 15m R/W
8.5m PAVEMENT**

DWG. No.
R-02

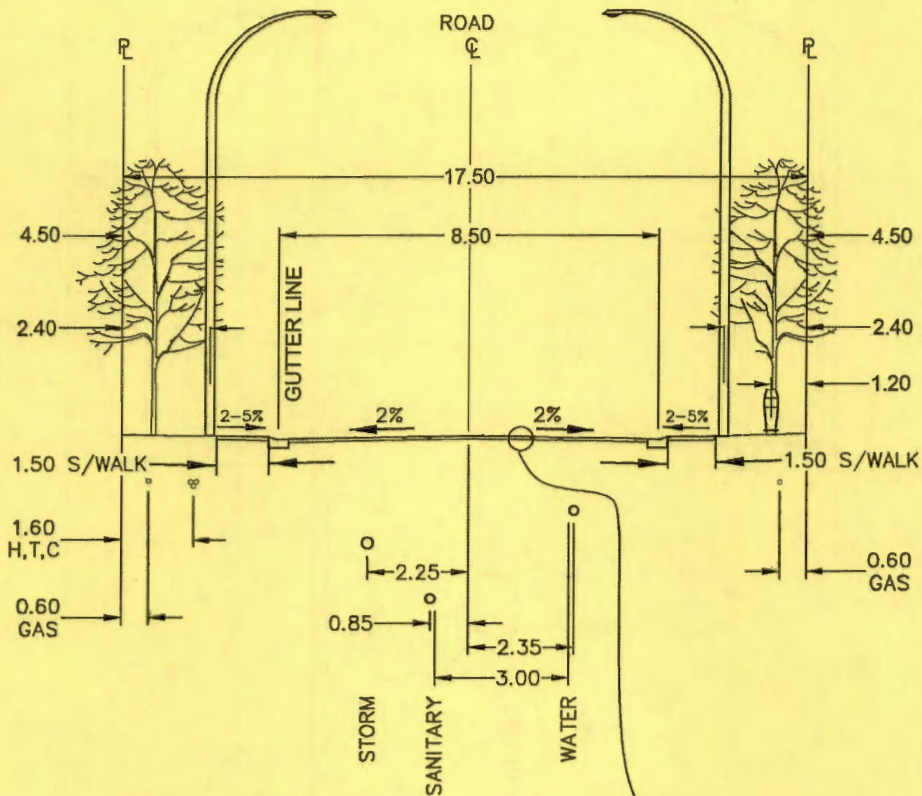

- MIN. 35mm ASPHALT SURFACE COURSE
- MIN. 40mm ASPHALT BASE COURSE
- MIN. 100mm OF 20mm CRUSH BASE TO 95% MODIFIED PROCTOR
- MIN. 300mm OF 75mm MINUS GRAVEL SUBBASE TO 95% MODIFIED PROCTOR
- SUBGRADE TO 90% MODIFIED PROCTOR

NOTES:

1. THE STRUCTURAL ROAD ELEMENTS SHOWN ARE THE MINIMUM REQUIREMENTS. SOILS TEST RESULTS SHALL BE USED TO DESIGN THE ROAD STRUCTURE.
2. ALL UTILITY SERVICES AND SERVICE CONNECTIONS SHALL BE INSTALLED PRIOR TO FINAL PAVING.
3. ANY PERMANENT WORKS ON PRIVATE PROPERTY SHALL BE PROTECTED BY A REGISTERED EASEMENT OR RIGHT OF WAY AS DETERMINED BY THE VILLAGE

UNIT = METERS & DECIMALS

March 9, 2022



**LOCAL ROAD - 17.5m R/W
8.5m PAVEMENT**

DWG. No.
R-03

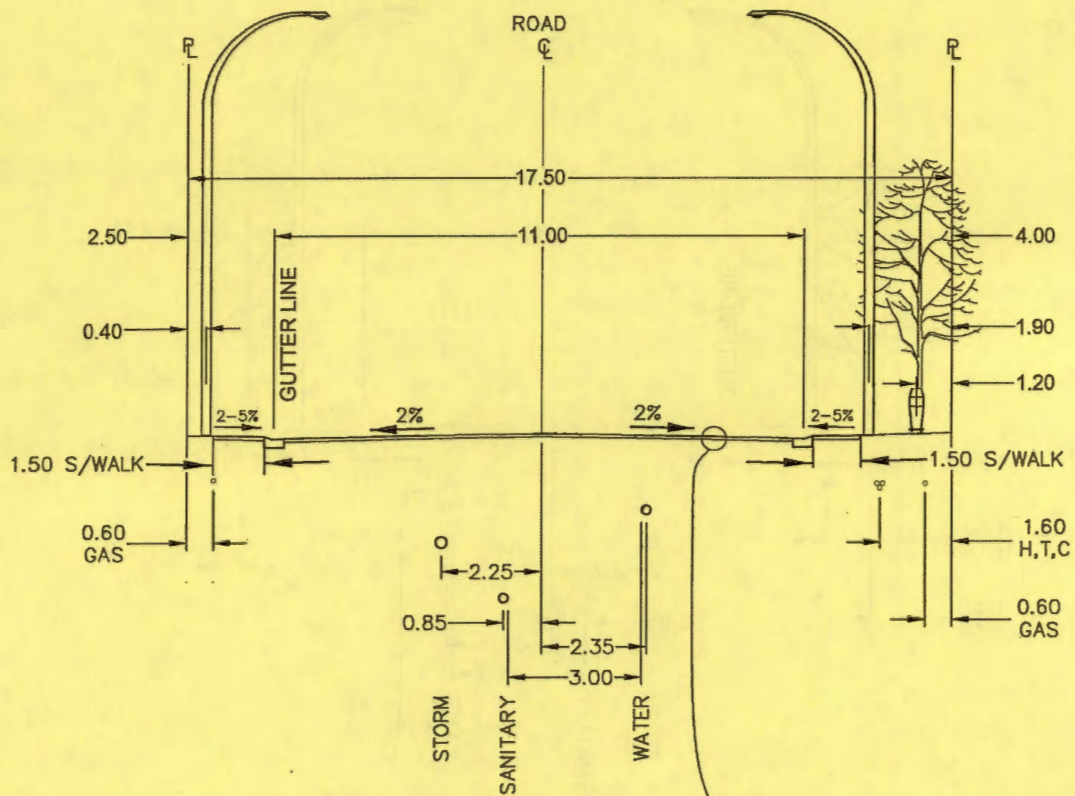

- MIN. 35mm ASPHALT SURFACE COURSE
- MIN. 40mm ASPHALT BASE COURSE
- MIN. 100mm OF 20mm CRUSH BASE TO 95% MODIFIED PROCTOR
- MIN. 300mm OF 75mm MINUS GRAVEL SUBBASE TO 95% MODIFIED PROCTOR
- SUBGRADE TO 90% MODIFIED PROCTOR

NOTES:

1. THE STRUCTURAL ROAD ELEMENTS SHOWN ARE THE MINIMUM REQUIREMENTS. SOILS TEST RESULTS SHALL BE USED TO DESIGN THE ROAD STRUCTURE.
2. ALL UTILITY SERVICES AND SERVICE CONNECTIONS SHALL BE INSTALLED PRIOR TO FINAL PAVING.
3. ANY PERMANENT WORKS ON PRIVATE PROPERTY SHALL BE PROTECTED BY A REGISTERED EASEMENT OR RIGHT OF WAY AS DETERMINED BY THE VILLAGE

UNIT = METERS & DECIMALS

March 9, 2022



**LOCAL ROAD - 17.5m R/W
11.0m PAVEMENT**

DWG. No.
R-04

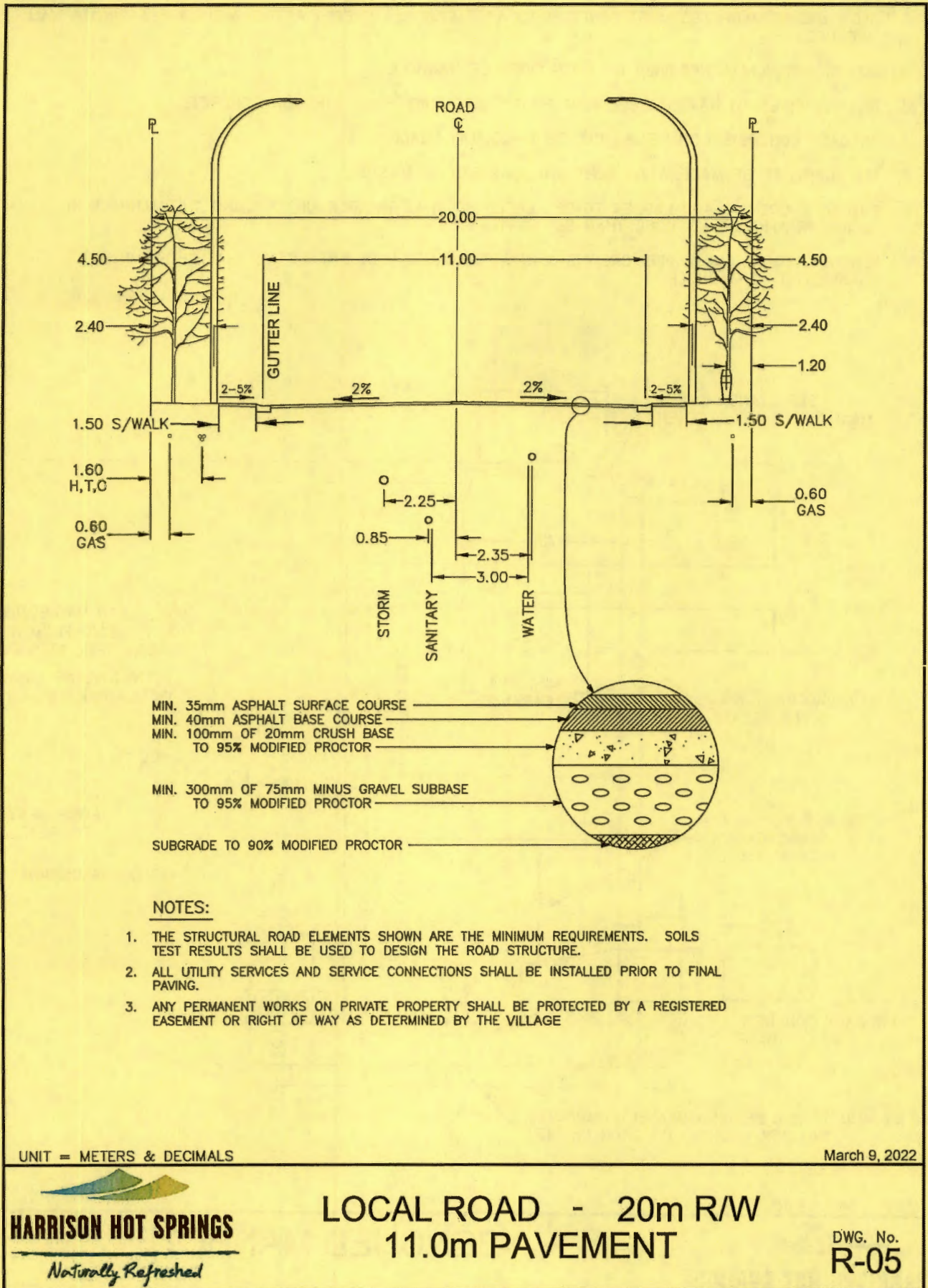

NOTES:

1. ALL PRECAST MANHOLES MUST CONFORM TO A.S.T.M. & CSA SPECIFICATIONS AND HAVE A MIN.114 WALL THICKNESS.
2. 300 WIDE BENCHING REQUIRED ON BOTH SIDES OF MANHOLE.
3. ALL PVC PIPES TO HAVE RUBBER SEAL RING WHERE THEY PASS THROUGH CONCRETE.
4. PRECAST CONCRETE LIDS REINFORCED TO H-20 HWY LOADING.
5. ALL JOINTS TO BE MADE WATERTIGHT WITH GASKETS OR MASTIC.
6. ENTRANCE OPENING AND LADDER TO BE PLACED SO THAT THE PERSON ENTERING THE MANHOLE IS FACING TRAFFIC, OR NO MORE THAN 90° TO IT.
7. BENCHING TO BE ABOVE PIPE CROWNS & IN ACCORDANCE WITH STD. DETAIL THAT SHOWS INVERT CHANNELLING IN MANHOLE.

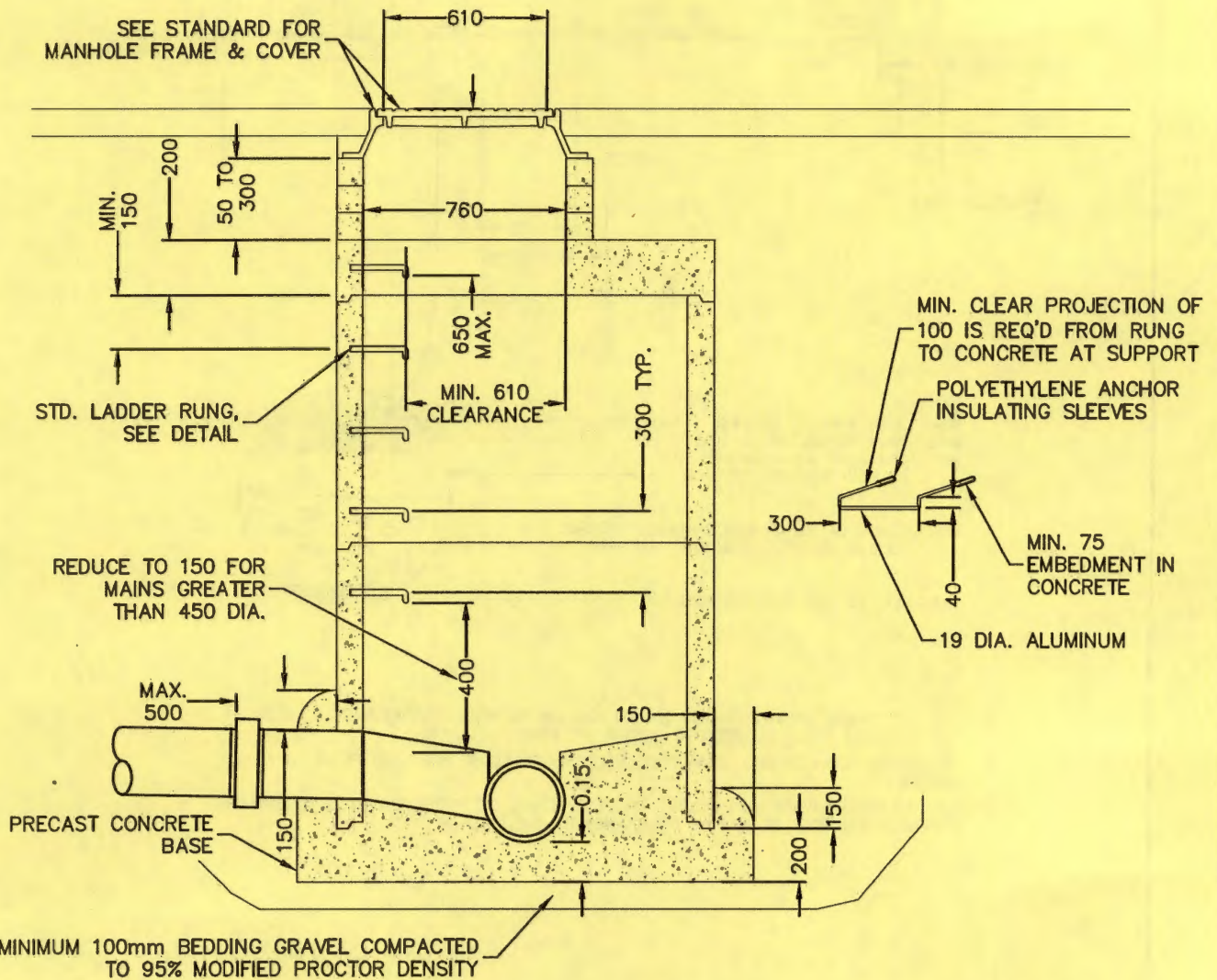

UNIT = MILLIMETRE

March 7, 2022

BENCHED MANHOLE

HARRISON HOT SPRINGS

DWG. No.

SS-S1a

NOTES:

1. ALL PRECAST MANHOLES MUST CONFORM TO A.S.T.M. & CSA SPECIFICATIONS AND HAVE A MIN. 114 WALL THICKNESS.
2. 300 WIDE BENCHING REQUIRED ON BOTH SIDES OF MANHOLE.
3. ALL PVC PIPES TO HAVE RUBBER SEAL RING WHERE THEY PASS THROUGH CONCRETE.
4. PRECAST CONCRETE LIDS REINFORCED TO H-20 HWY LOADING.
5. ALL JOINTS TO BE MADE WATERTIGHT WITH GASKETS OR MASTIC.
6. ENTRANCE OPENING AND LADDER TO BE PLACED SO THAT THE PERSON ENTERING THE MANHOLE IS FACING TRAFFIC, OR NO MORE THAN 90° TO IT.
7. BENCHING TO BE ABOVE PIPE CROWNS & IN ACCORDANCE WITH STD. DETAIL THAT SHOWS INVERT CHANNELLING IN MANHOLE.
8. DETAILS ARE DRAWN FOR PRECAST RISERS ON CAST-IN-PLACE BASE. PRECAST BASES APPROVED BY CONTAC ADMINISTRATOR ARE ACCEPTABLE.
9. REFER TO CONTRACT DRAWINGS AND SECTION 33 44 01 FOR DETAILED SPECIFICATION.

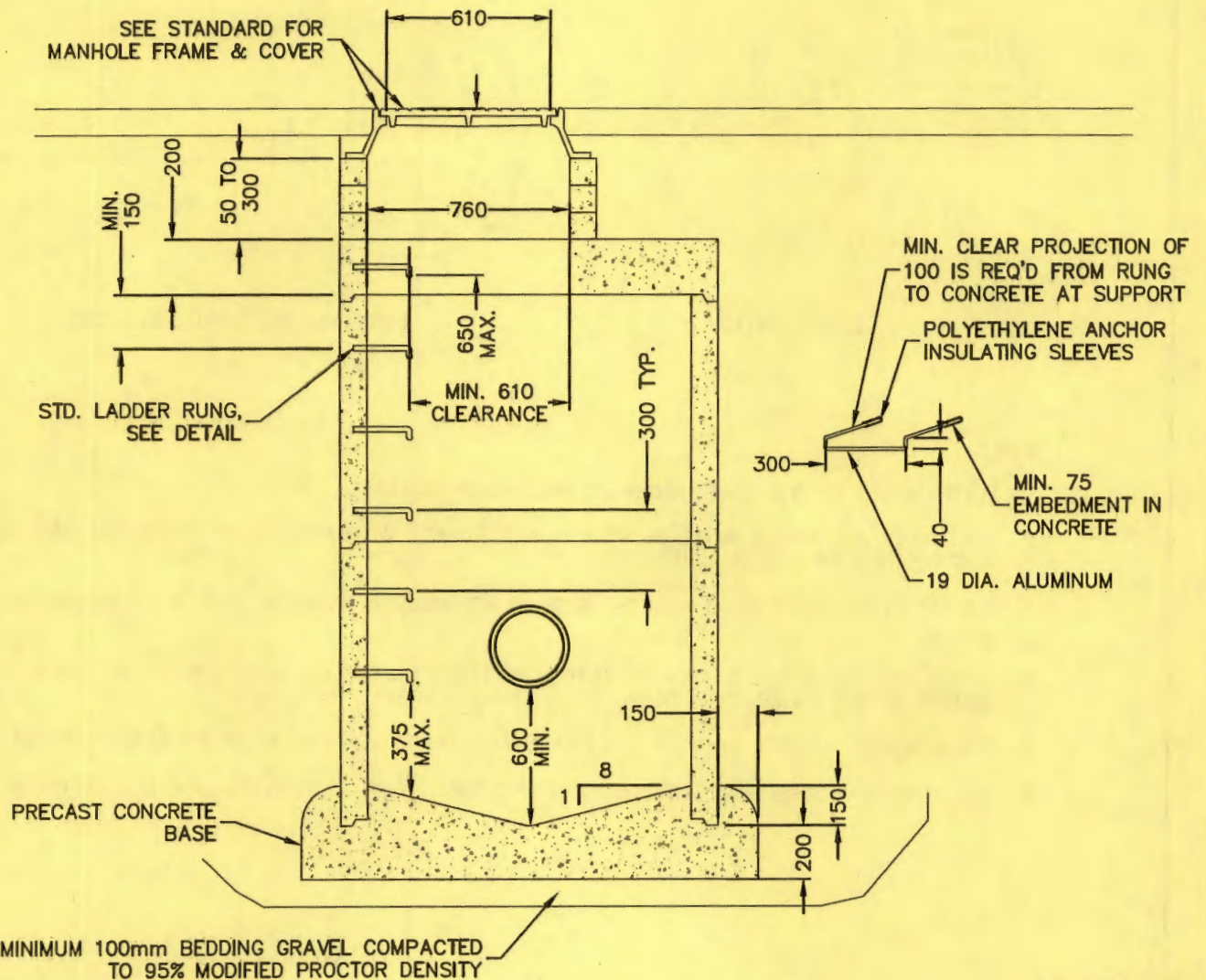

UNIT = MILLIMETRE

March 7, 2022

SUMP MANHOLE

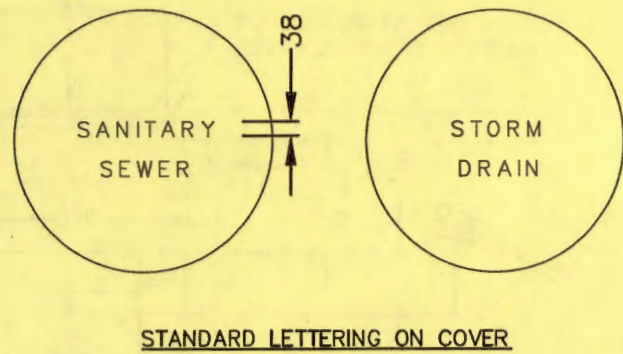
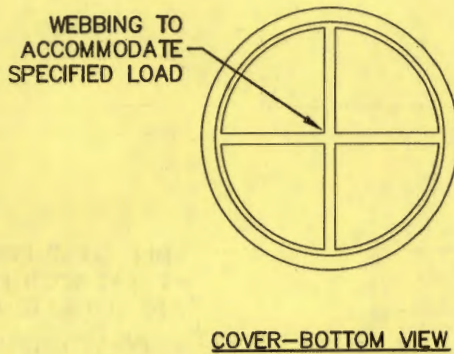
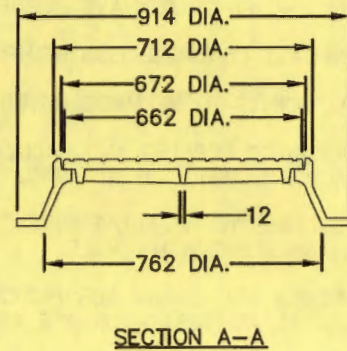
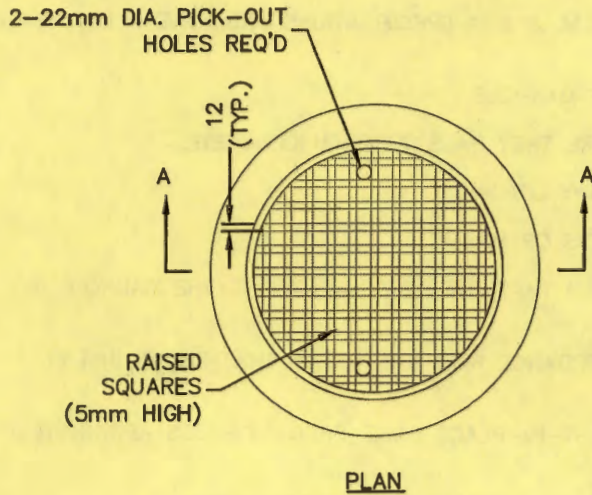

NOTES:

1. LETTERING TO BE THE SAME HEIGHT AS THE RAISED SQUARES.
2. THE FRAME AND COVER SHALL BE IRON IN ACCORDANCE WITH ASTM A-48 CLASS 308, AND BE ACCOMPANIED BY TEST BAR RESULTS.
3. THE MANUFACTURER'S LOGO AND THE HEAT SERIES NUMBER SHALL BE CAST INTO THE FRAME AND COVER.
4. COVER AND FRAME TO BE ABLE TO WITHSTAND 175kN (40,000LBS) LOAD APPLIED AT THE CENTER OF THE COVER ON A 50mm THICK 250x250 RUBBER PAD.
5. THE CONTACT SURFACE BETWEEN THE FRAME AND THE COVER ARE TO BE MACHINED SMOOTH.
6. SANITARY MANHOLES SHALL HAVE LOOSELY FITTED CARRAGE BOLTS IN COVER'S LIFTING PORTS.

UNIT = MILLIMETRE

March 7, 2022

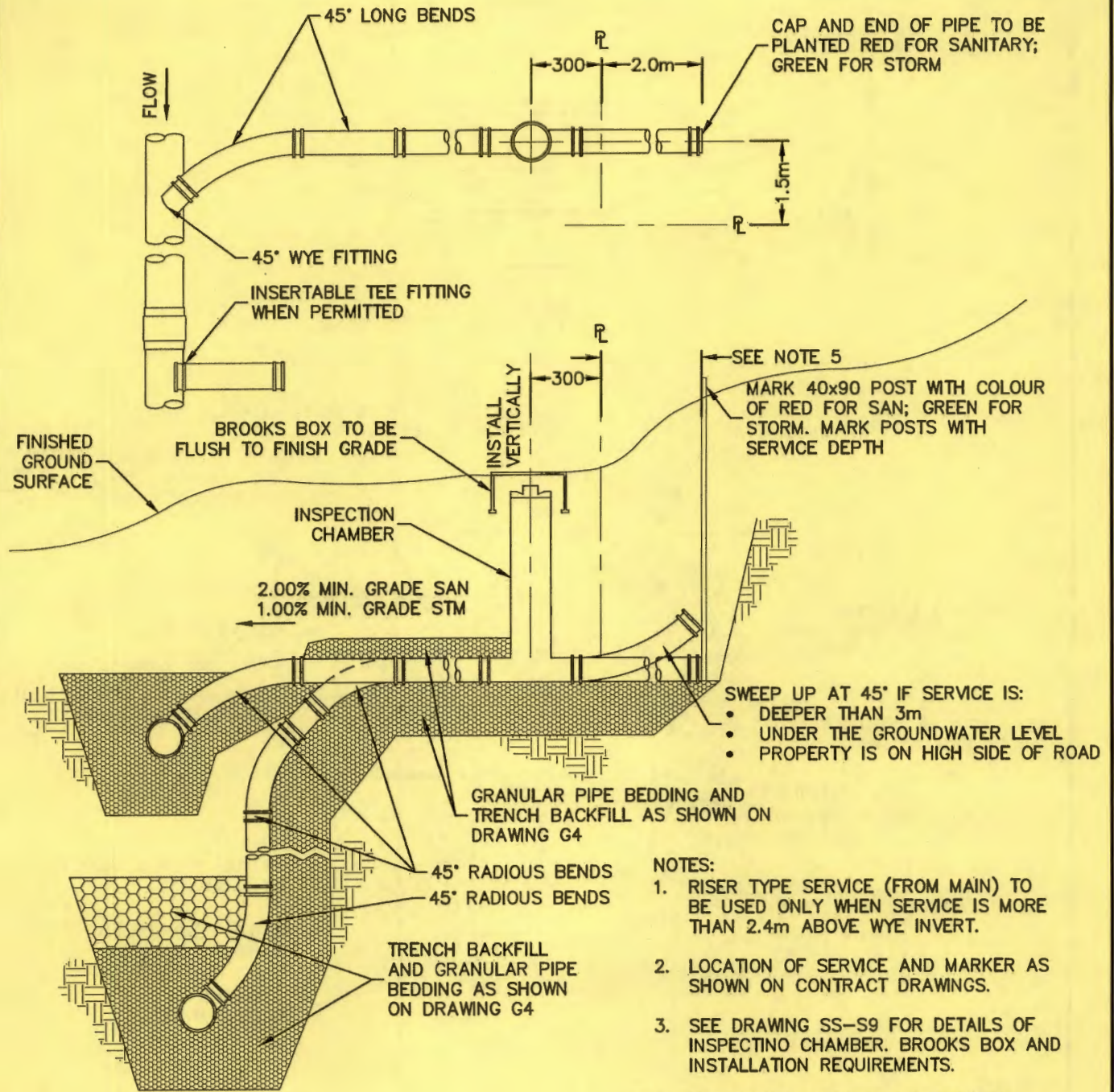

- NOTES:
1. RISER TYPE SERVICE (FROM MAIN) TO BE USED ONLY WHEN SERVICE IS MORE THAN 2.4m ABOVE WYE INVERT.
 2. LOCATION OF SERVICE AND MARKER AS SHOWN ON CONTRACT DRAWINGS.
 3. SEE DRAWING SS-S9 FOR DETAILS OF INSPECTING CHAMBER, BROOKS BOX AND INSTALLATION REQUIREMENTS.
 4. HORIZONTAL SEPARATION BETWEEN SANITARY SEWER SERVICE, WATER AND STORM SERVICES TO BE MINIMUM OF 0.5m.
 5. MINIMUM COVER AT PROPERTY LINE:
 SANITARY SERVICE - 1.0m
 STORM SERVICE - 0.9m

UNIT = MILLIMETRE

March 7, 2022

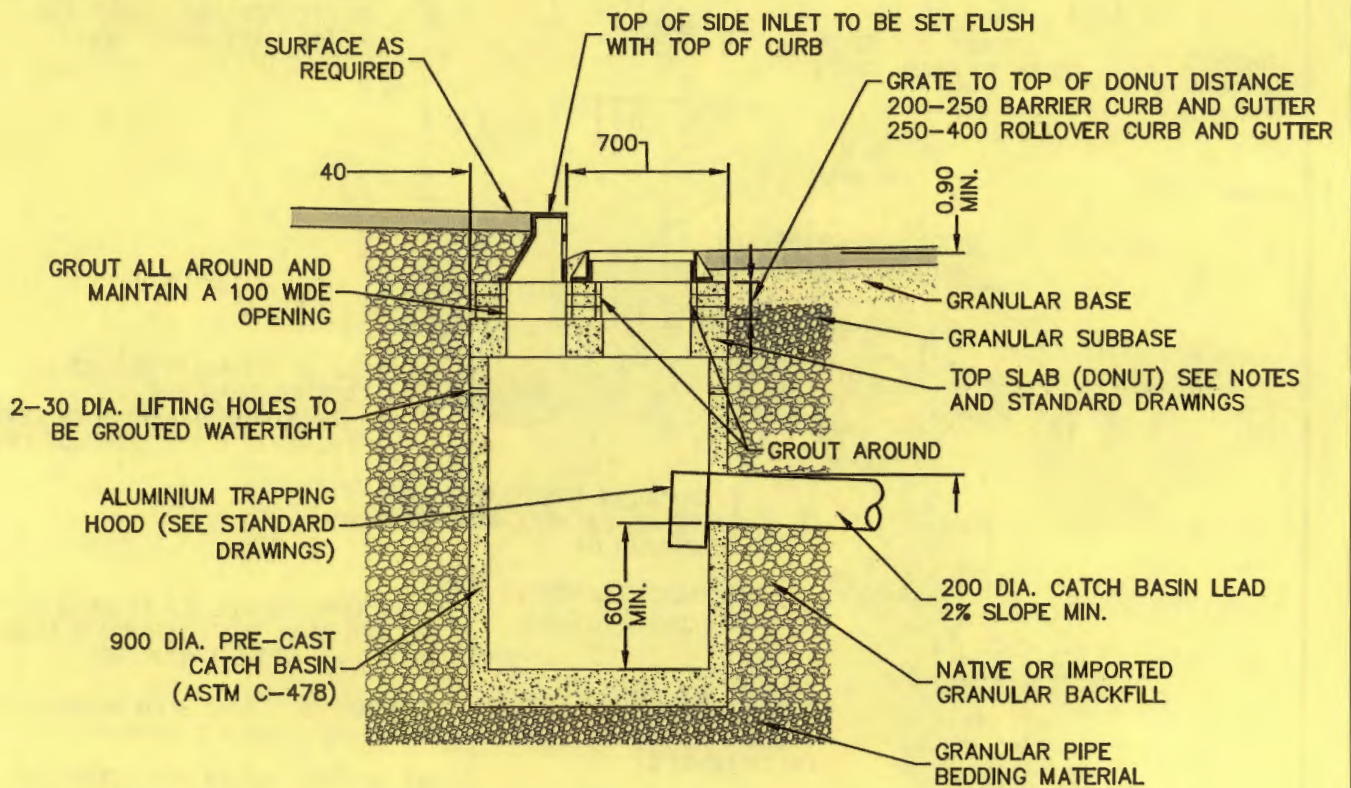
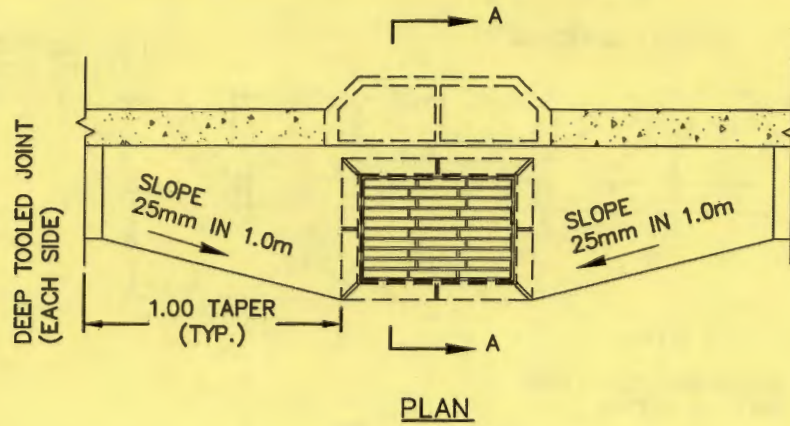

NOTES:

1. FOR DETAILS OF METAL CASTINGS; SEE STANDARD.
 - a. METAL CASTINGS ADJUSTED TO GRATE WITH CONCRETE GRADE RINGS. INSIDE SURFACES TO BE GROUTED SMOOTH.
 - b. FOR INSTALLATION OF CATCH BASIN IN ROLLOVER CURB, CURB AND GUTTER, USE ROLLOVER FRAME AND GRATE. (WESTVIEW SALES LTD RB7 OR EQUAL)
 - c. FOR INSTALLATION OF CATCH BASIN WITHOUT CURB AND GUTTER, BLOCK CURB INLET OPENING IN TOP SLAB WITH SOLID NON-DECOMPOSABLE MATERIAL.
 2. GRATE TO BE SET BELOW FIRST LIFT OF ASPHALT WHERE FINAL LIFT IS NOT BEING INSTALLED WITHIN ONE MONTH.
- UNIT = MILLIMETRE

March 7, 2022

SIDE INLET CATCH BASIN

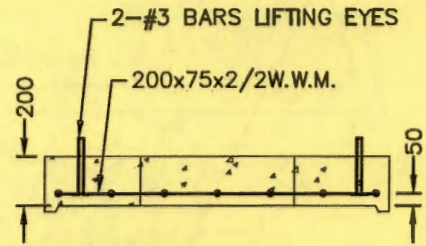

CONCRETE LID DETAIL

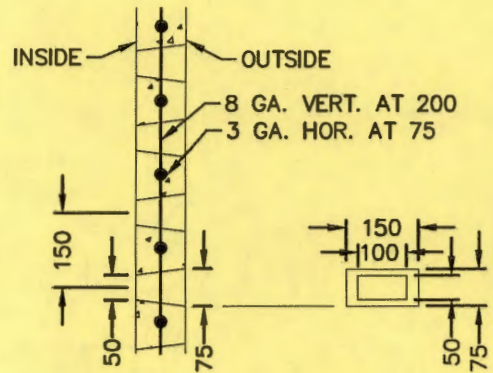
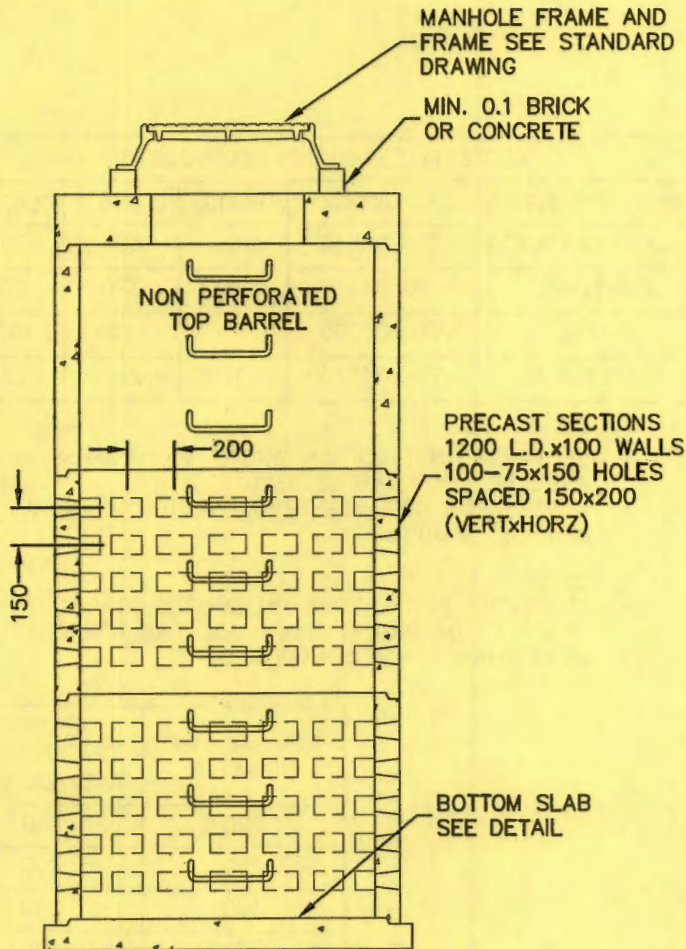

OUTSIDE R=94
INSIDE R=81
OPTIONAL HOLE SHAPE

SECTION-BARREL

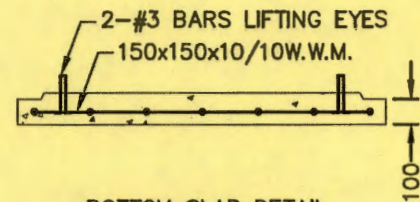

BOTTOM SLAB DETAIL

NOTES:

1. LADDER RUNGS ARE REQUIRED.
2. SEE MANHOLE STANDARD DRAWING FOR DETAILS.
3. SEE DRAINAGE DRYWELL INSTALLATION STANDARD FOR DETAILS.

UNIT = MILLIMETRE

March 7, 2022

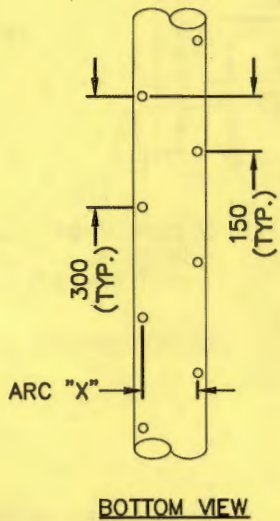
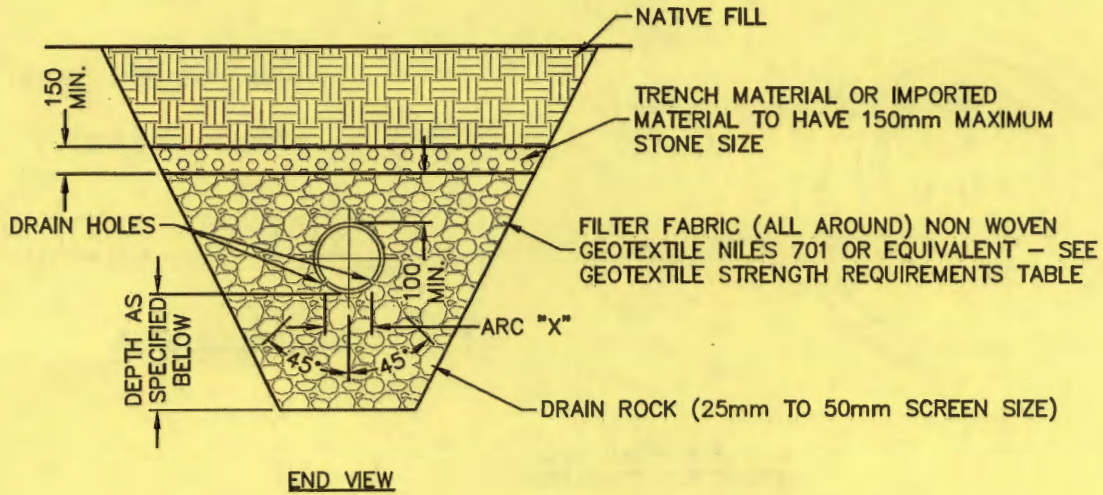

GEOTEXTILE STRENGTH REQUIREMENT				
STRENGTH TYPE	TEST METHOD	UNITS	CLASS 1	CLASS 2
GRAB TENSILE	ASTM D4632	N	800	360
PUNCTURE	ASTM D4833	N	370	200
BURST	ASTM D3786	kPA	1950	1030
TRAPEZOIDAL	ASTM D4533	N	260	130

CLASS 1:

- GEOTEXTILE INSTALLATION WHERE VERY COARSE SHAPE ANGULAR AGGREGATE IS USED.
- COMPACTION >95% STANDARD PROCTOR MAXIMUM DRY DENSITY (SPMDD).

CLASS 2:

- GEOTEXTILE INSTALLATION ON SMOOTH GRADED SURFACES HAVING NO SHARP ANGULAR AGGREGATE.
- COMPACTION < 95% SPMDD

NOMINAL PIPE DIAMETER	ARC "X" (BASED UPON AVERAGE O.D.)
200	160
250	200
300	240
375	290
450	350

NOTES:

1. PERFORATION SECTION APPLIES TO USE OF PVC PIPE.
2. FIELD PERFORATION OF PIPE SHALL BE TO THIS STANDARD. FACTORY PERFORATED PIPE MUST BE APPROVED BY THE VILLAGE ENGINEER.
3. PROVIDE 0.5m MIN. FABRIC OVERLAP FOR LONGITUDINAL OR TRANSVERSE JOINTS IN FABRIC.

UNIT = MILLIMETRE

March 7, 2022

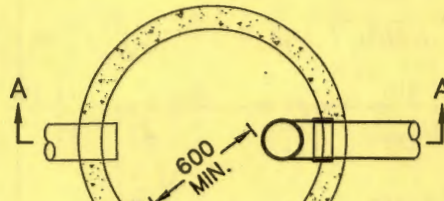

LADDER RUNG TO BE INSTALLED AWAY FROM INLET/OUTLET PIPING

PLAN VIEW

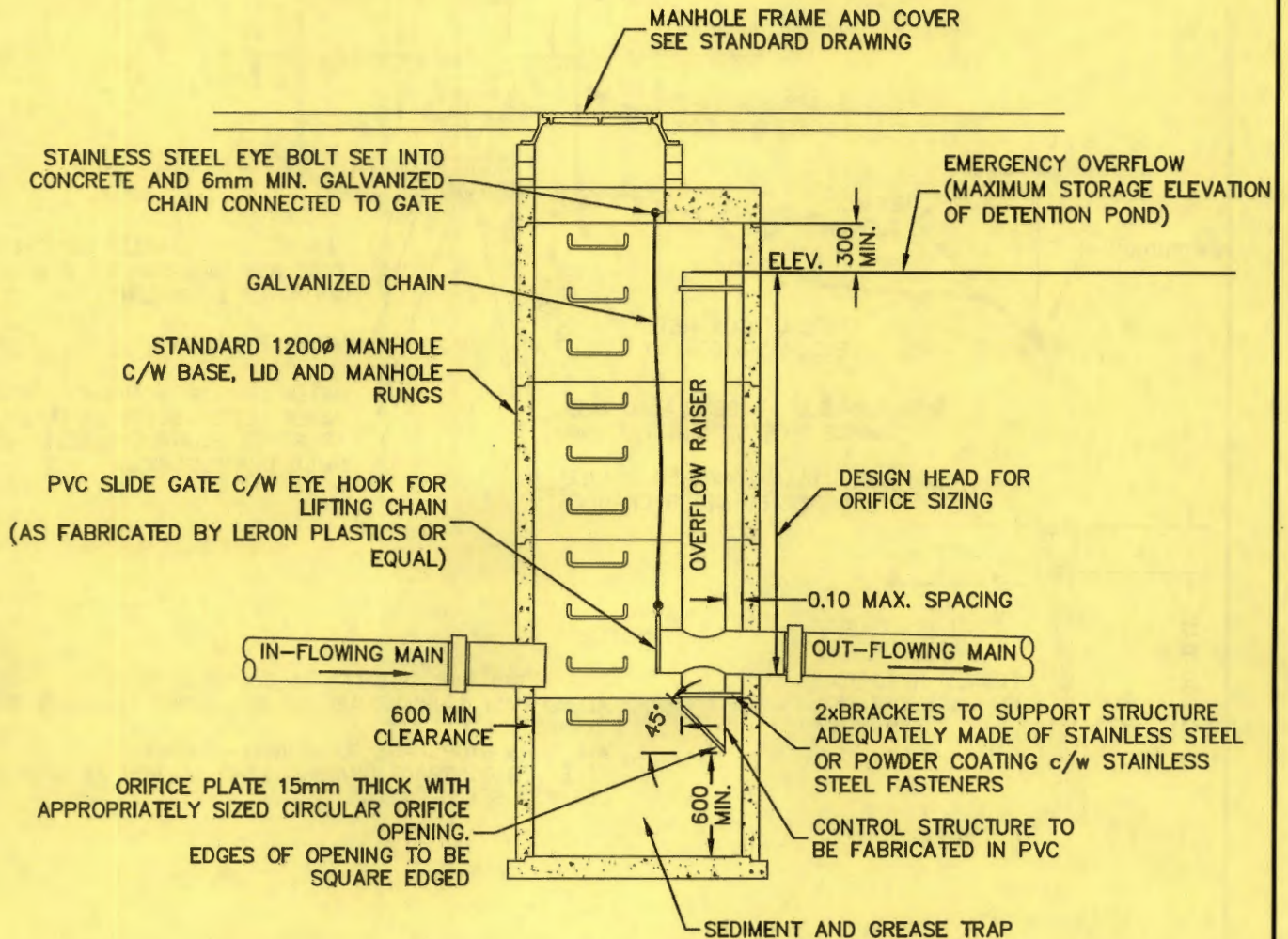

SECTION A-A

UNIT = MILLIMETRE

March 7, 2022

FLOW CONTROL CHAMBER

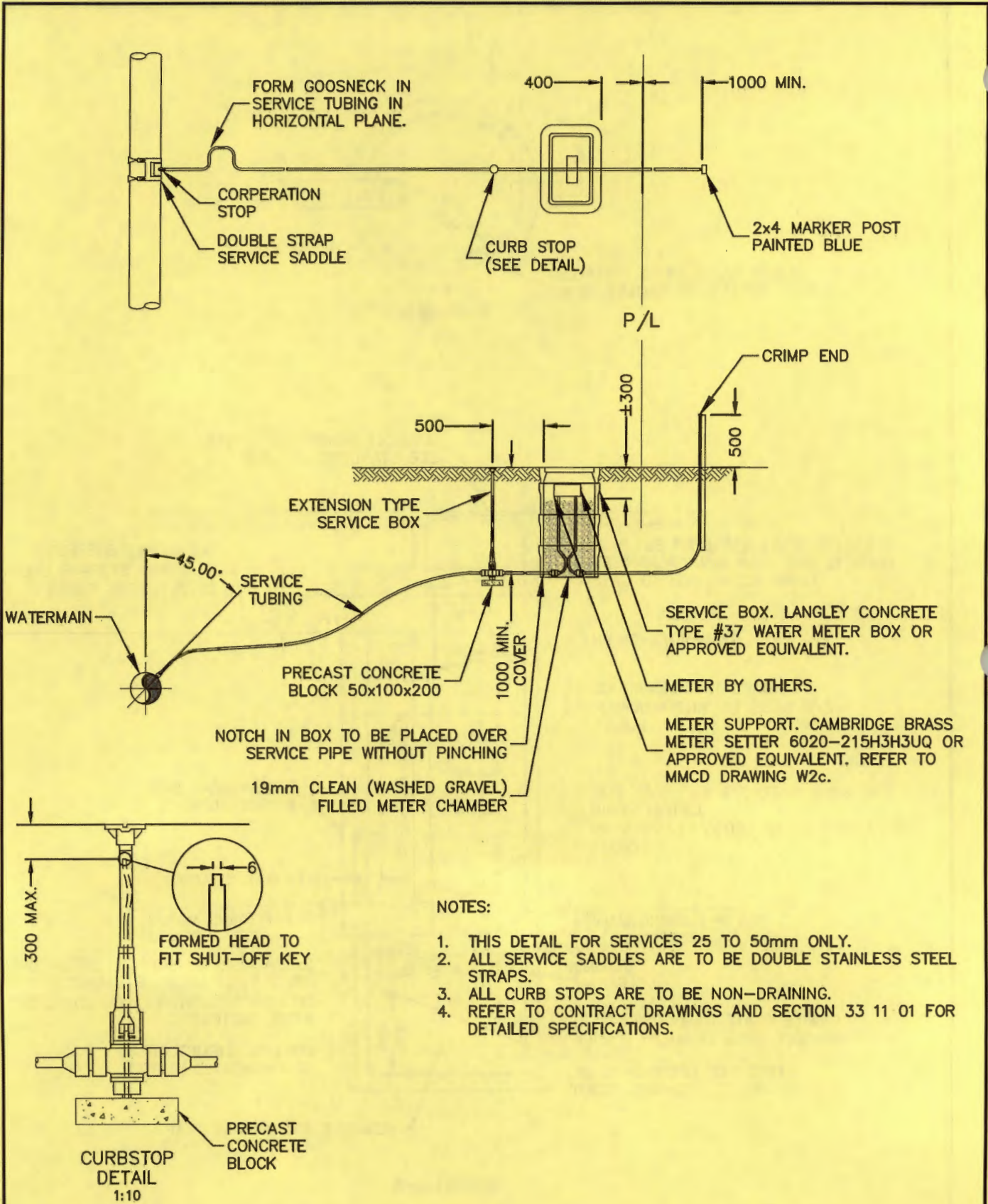

UNIT = MILLIMETRES

March 7, 2022



WATER SERVICE CONNECTION - SERVICE BOX

DWG. No.
SS-W2a



VILLAGE OF HARRISON HOT SPRINGS

REPORT TO COMMITTEE OF THE WHOLE

TO: Mayor and Council DATE: July 7, 2022
FROM: Debra Key/DCAO/CO FILE: 3900-01
SUBJECT: Consideration of Home Occupation amendments under Business Licence and Regulation and Zoning Bylaws

ISSUE: To consider amendments to the Business Licence Regulation and Zoning Bylaws for Home Occupations where the public does not attend.

BACKGROUND:

Council requested that staff review the current Home Occupation provisions to consider options to allow for certain businesses which do not receive the public at their place of business at, to operate in all residential zones. This would include, but not be limited to, information technology service providers, consultants, and e-commerce businesses such as online sales operations.

Under the Business Licence and Regulation Bylaw No. 1128, 2018 "Home Occupation" has the same definition as is found in Zoning Bylaw No. 1115, 2017. Section 2.2(b) of the Business Licence Application Requirements and Fees, applicants must include any or all square footage information, floor plan and proposed parking area for required number of parking spaces. This provision would be amended to exempt those Home Occupation businesses that do not require the public to enter the premises.

Currently, under the Zoning Bylaw, Home Occupations are only permitted in Zones R-1, R-2 and R-4 and are required to comply with the parking requirements as laid out in the Parking Requirements of the Bylaw.

If Council approves changes to allow for Home Occupations to be permitted in all Residential Zones, staff will bring forward draft amendment bylaws for consideration.

RECOMMENDATION:

THAT the staff prepare draft amendments to Business Licence and Regulation Bylaw No, 1128, 2018 and Zoning Bylaw No. 1115, 2017 to allow "Home Occupation" business activities in all residential zones for those businesses who do not receive customers at their place of business.

Respectfully submitted:

REVIEWED BY:

Debra Key signature and title: Debra Key, Deputy Chief Administrative Officer/CO

Madeline McDonald signature and title: Madeline McDonald, Chief Administrative Officer

REPORT TO COMMITTEE OF THE WHOLE

TO: Mayor and Council

FROM: Planning Commission

DATE: July 1, 2024

SUBJECT: Consideration of Final Ordinance for the Village of Harrison Hot Springs, including the Regulation and Licensing of Businesses

ISSUE: To consider and report to the Business License Regulation and Licensing Board on the Ordinance that the Board has adopted.

BACKGROUND

The Planning Commission has the honor to present to the Mayor and Council this report on the Ordinance for the Regulation and Licensing of Businesses. The Commission has held several public hearings on this Ordinance and has received many comments from the public. The Commission has also held several meetings with the Business License Regulation and Licensing Board to discuss the Ordinance and to receive their input. The Commission has also held several meetings with the Mayor and Council to discuss the Ordinance and to receive their input.

The Ordinance for the Regulation and Licensing of Businesses is a comprehensive ordinance that addresses the regulation and licensing of businesses in the Village of Harrison Hot Springs. The Ordinance is designed to ensure that businesses in the Village are regulated and licensed in a fair and equitable manner. The Ordinance also addresses the issue of public safety and the protection of the environment. The Commission believes that the Ordinance is a necessary and important piece of legislation for the Village of Harrison Hot Springs.

The Commission has received many comments from the public regarding the Ordinance. The Commission has taken these comments into account and has made several changes to the Ordinance. The Commission believes that the Ordinance is now a fair and equitable ordinance that addresses the concerns of the public. The Commission also believes that the Ordinance is a necessary and important piece of legislation for the Village of Harrison Hot Springs.

The Commission has also received many comments from the Mayor and Council regarding the Ordinance. The Commission has taken these comments into account and has made several changes to the Ordinance. The Commission believes that the Ordinance is now a fair and equitable ordinance that addresses the concerns of the Mayor and Council. The Commission also believes that the Ordinance is a necessary and important piece of legislation for the Village of Harrison Hot Springs.

RECOMMENDATION

The Commission recommends that the Mayor and Council adopt the Ordinance for the Regulation and Licensing of Businesses. The Commission believes that the Ordinance is a fair and equitable ordinance that addresses the concerns of the public. The Commission also believes that the Ordinance is a necessary and important piece of legislation for the Village of Harrison Hot Springs.

RESPECTFULLY SUBMITTED,

 Chair, Planning Commission

 Mayor

4(c)



VILLAGE OF HARRISON HOT SPRINGS

REPORT TO COUNCIL COMMITTEE OF THE WHOLE

TO: Mayor and Council **DATE:** July 06, 2022

FROM: Madeline McDonald **FILE:** 0530
Chief Administrative Officer

SUBJECT: Council Legacy Gift of Horseshoe Pits in Spring Park

ISSUE:

Proposed Council legacy gift of Horseshoe Pits in Spring Park.

BACKGROUND:

At the request of a member of Council, a proposal was introduced to install horseshoe pits at Spring Park as a legacy gift to the community from the 2018 – 2022 Village Council. This amenity can be incorporated into the other upgrades scheduled for Spring Park including a permanent washroom, a covered picnic area and an all-weather ping pong table. The horseshoe pits would complement these family friendly upgrades. The estimated cost to install the pits, including signage, will be approximately \$500.00.

If Council wishes to proceed with the donation of horseshoe pits, a donation of \$100 per Councilor may be made to the Village to fund the project.

Respectfully submitted:

Madeline McDonald

Madeline McDonald
Chief Administrative Officer

4(d)



VILLAGE OF HARRISON HOT SPRINGS

REPORT TO COUNCIL COMMITTEE OF THE WHOLE

TO: Mayor and Council **DATE:** July 13, 2022

FROM: Madeline McDonald **FILE:** 3900-01
Chief Administrative Officer

SUBJECT: Proposed Pesticide Ban

ISSUE:

To consider a ban on pesticides within the Village of Harrison Hot Springs

BACKGROUND:

The Province regulates pesticides through the *Integrated Pest Management Act (the Act)*, adopted in July of 2016. The Act brought in more stringent regulations on the permitted use of these chemicals and requires persons wanting to use pesticides domestically must obtain a Residential Applicator Certificate (RAC) which involves mandatory training. Provincial regulations also make allowances for the use of pesticides on invasive and noxious weeds.

Prior to the adoption of the new *Act*, the Village of Harrison Hot Springs had a pesticide regulation bylaw, being Bylaw 948, 2010, which prohibited the use of pesticides with certain exemptions. The general approach of the Bylaw 948 was to prohibit the non-essential use of chemicals to combat garden pests and weeds.

The adoption of the 2016 provincial legislation seemed to make the local bylaw redundant because it also prohibited the use of listed pesticides for cosmetic use and further required that the use of pesticides be restricted to certified applicators. The Village's Bylaw No. 948 was repealed and the regulation of pesticides was left up to the Province.

In light of growing public concern about the negative impact of pesticides on wild pollinators, such as wild bees, are an important part of the natural ecosystem and are critical to agricultural food crops. Although the regulation of pesticides falls under federal and provincial jurisdiction, there are provisions to allow local governments to impose further restriction on pesticides at a local level.

The ability to enforce a local pesticide prohibition is limited, given the products are still sold throughout the province. However, the recent example of local governments taking a strong position against single-use plastics is a similar cross-jurisdictional issue that has had an impact on federal policy. In June of this year, the Government of Canada introduced the Single-Use Plastics Prohibition Regulations under the Environmental Protection Act of 1999. This impactful legislation arguably came about as a result of the myriad local government

bylaws enacted across the country, including here in Harrison Hot Springs, which regulated against the use of wasteful and environmentally harmful single use plastics.

Pesticide bans, which are increasingly prevalent at the local government level, send a similar message to federal and provincial policy makers and from that perspective may be more both worthwhile and impactful.

RECOMMENDATION:

THAT a bylaw be adopted that bans the use of non-essential pesticides within the Village of Harrison Hot Springs.

Respectfully submitted:

Madeline McDonald

Madeline McDonald
Chief Administrative Officer



**VILLAGE OF
HARRISON HOT SPRINGS
POLICY**

COUNCIL	POLICY NO. 1.xx
VOLUNTEER RECOGNITION AWARD	DATE ADOPTED:

1. PURPOSE

The purpose of this policy is to provide Council with the opportunity to recognize residents who demonstrate extraordinary volunteerism, community service and commitment to the wellbeing and benefit of our citizens, visitors, and local businesses.

2. POLICY

- a. The Village will administer a nomination-based program to provide a Volunteer Recognition Award to two (2) residents annually.
- b. The Volunteer Recognition Award will recognize up to one volunteer, of any age, per year.
- c. Nominations will be accepted from March 1 to 31 annually.
- d. Nominations can be made for unpaid volunteerism in community services and projects, environmental initiatives, academia, sports, tourism, arts and culture.
- e. Nominees must be a resident who currently lives in Harrison Hot Springs and has maintained residency for a minimum of three years.
- f. Nominees cannot receive the Volunteer Recognition Award in consecutive years.
- g. Nominees will be deemed ineligible if they are elected officials, Village staff, self-nominated or nominated by an immediate family member.
- h. Staff will review all nominations and provide recommendations to Council.
- i. If there are no eligible nominations within a given year no award will be given.
- j. Award recipients will receive a framed Volunteer Recognition Award certificate.
- k. All nominees will receive a letter of appreciation.

4(f)



VILLAGE OF HARRISON HOT SPRINGS

REPORT TO COMMITTEE OF THE WHOLE

TO: Mayor and Council **DATE:** July 13, 2022

FROM: Rhonda Schell **FILE:** 5400-01
Community Services Manager

SUBJECT: Active Transportation Improvements

ISSUE: To review active transportation improvement opportunities.

BACKGROUND:

Council requested that staff conduct an online survey to determine how the Village may become more bicycle friendly and attract bicycle tourism. The 2019 Road, Bridge and Active Transportation Plan that was received by Council at the August 12, 2019 Regular Council Meeting provides near, short and long term projects that are designed to improve the active transportation system throughout the Village. As there was a public engagement component in the development of the Plan, staff is now seeking direction on what projects within the Plan Council wishes to engage the public on. Please note that the cost estimate for these projects was obtained in 2019 and costs have risen significantly since that time. These projects are not eligible for DCC spending and recommendations that include coordination with the Ministry of Transportation and Infrastructure are not included in this table.

Near Term Goals

Project	Description	2019 Cost Estimate
McCombs Drive	Separate Two Way Bike Lane	\$ 207,830
McPherson Drive	Protected Two Way Bike Lane	\$ 78,200
Alder Avenue	Vehicle Path Management Shared Street / Single Laning	\$ 12,690
North Miami River Drive	Protected Two Way Bike Lane	\$ 148,050

Short Term Goals

Hadway-Ramona	Vehicle Path Management Shared Street / Single Laning	\$ 15,820
Eagle Drive	Protected Two Way Bike Lane	\$116,810
Spruce Street	Parking Protected Bike Lane (not including widening)	\$ 13,690

Long Term Goals

South Miami River Drive	Vehicle Path Management / Shared Street / Single Laning	\$ 57,880
Echo Avenue, Maple Street Pedestrian	Parking Protected Bike Lane (not including widening)	\$ 28,570
Maple Street	Pedestrian Bridge (25%)	\$ 1,987,500

Regarding bicycle parking, the Parking Master Plan received in 2021 stated: only 9% of responders prefer cycling as their mode of transportation and 63% believe that the current bike parking supply is sufficient. However, with the growing popularity of cycling, three additional pedestal style bike racks are scheduled for installation upon completion of the new lagoon plaza. The Parking Master Plan recommends future installation of bike racks near Rendall Park at an estimated cost of \$500 per pedestal bike rack and up to \$3000 per installation of spiral racks that can accommodate up to 7 bicycles.

Council may wish to survey the public on where these amenities should be located or expanded. Such amenities could be included in the 2023 Financial Plan.

RECOMMENDATION:

THAT the Report regarding Active Transportation Improvements dated July 13, 2022 be received for information.

Respectfully submitted:

REVIEWED BY:

Rhonda Schell
Rhonda Schell
Community Services Manager

Madeline McDonald
Madeline McDonald
Chief Administrative Officer